



S3970BE

S3370BE

S2770BE

S3970RT

S3370RT

S2770RT



Diesel
Gasoline
LPG
Bi-Energy 24V DC

OPERATION MANUAL

Serial Numbers:

S2770RT-07-161200500,
S3370RT-07-180300500,
S3970RT-07-180300500 and after

Part Number 15124-2

March 2018 (Rev A)

Version 7

■ Electrocutation Hazard Warning



DANGER

S3970RT, S3370RT & S2770RT ELEVATING WORK PLATFORMS ARE NOT ELECTRICALLY INSULATED

If the platform, scissor arms assembly or any other conductive part of the machine contacts a high voltage electrical conductor the result can be **SERIOUS INJURY** or **DEATH** for persons on or near the machine.



GO NO CLOSER THAN THE MINIMUM SAFE APPROACH DISTANCES (M.S.A.D) - SEE BELOW

Be sure to allow for sag and sway in the wires and the work platform.

If the machine comes in contact with a live electrical conductor, the entire machine can be charged.

If that happens, you should remain on the machine and not contact any other structure or object within reach. That includes the ground, adjacent buildings, poles, and any other object not part of the machine.

Such contact could make your body a conductor to the other object creating an electrical shock hazard resulting in **SERIOUS INJURY** or **DEATH**.

DO NOT attempt to enter or leave the machine until you are sure the electricity has been turned off.

If the machine is in contact with a live conductor, the platform operator **MUST** warn others on the ground in the vicinity of the machine to **STAY AWAY** from the machine, since their bodies can also form a path for electricity to ground thus creating an electrical shock hazard with possible **ELECTROCUTION** and **DEATH**.

DO NOT attempt to operate the machine ground controls when the platform, scissor arms assembly or any other conducting part of the machine is in contact with electrical wires or if there is an immediate danger of such contact.

Regard all conductors as energised.

Personnel working on or near the machine must be continuously aware of electrical hazards, recognizing that **SERIOUS INJURY** or **DEATH** can result if contact with an electrical wire does occur.

▲ IMPORTANT - M.S.A.D.

It is the operators responsibility to ensure M.S.A.D., (Subject to local regulations and laws), are known and adhered to.

The most important chapter in this manual is the safety chapter - Chapter 1. Take time now to study it closely.

The information in chapter 1 might save your life, prevent serious injury or damage of property to the S2770RT / S3370RT / S3970RT.

This introduction also contains important information concerning the responsibilities of the owner of the machine.

■ Standard S3970RT / S3370RT / S2770RT Version III

The standard S3970RT/S3370RT/S2770RT includes the following features:

- Fully proportional one (1) handed joy stick control
- Reliable diesel engine
- Large 1200mm multi position extension deck
- 30% 35% gradeability
- 4 wheel drive
- Hour Meter
- Temperature & ammeter gauges
- Easy access side trays for engine & hydraulics
- Lockable hinged covers
- Independently operated hydraulic stabilisers with auto level
- Swinging gate
- Independent articulating rear axles
- Forklift pockets
- Lifting lugs and tie down rings
- Flashing light

■ Options

The following options are available for the S3970RT / S3370RT / S2770RT:

- No stabilisers
- Non-marking tyres
- 110/240V power to platform
- RCD/ELCB Outlet
- Alternative power options
 - Gasoline engine*
 - LPG engine*
 - Combination LPG/Gasoline engine*
 - Bi-Energy 24V DC / Diesel engine*

■ Operation Manual

This manual provides information for sale and proper operation of the aerial platform. Read and understand the information in this Operator's manual before operating this machine on a job site.

Additional copies of this manual may be ordered from Snorkel. Supply the model and manual part number from the front cover to assure the correct manual will be supplied.

All information in this manual is based on the latest product information at the time of publication. Snorkel reserves the right to make product changes at any time without obligation.

■ Photographs

Photographs are taken to represent the machine and its component parts as clearly as possible. However, there may be minor differences between the photographs and your machine. This represents individual customer preferences and Snorkel's ongoing commitment to product development.

■ Safety Alerts

A safety alert symbol is used throughout this manual to indicate danger, warning and caution instructions. Follow these instructions to reduce the likelihood of personal injury, property damage or damage to the machine.

The terms danger, warning and caution indicate varying degrees of personal injury or property damage that can result if the instruction is not followed.

DANGER

Denotes an Imminently hazardous situation which if not avoided, will result in serious injury or death.

WARNING

Denotes a potentially hazardous situation which if not avoided, could result in serious injury or death.

CAUTION

Denotes a potentially hazardous situation which if not avoided, may result in minor or moderate injury.

It may also be used to alert against unsafe practices or action which may result in damage to the machine.

IMPORTANT

Denotes important informations pertaining to settings, capacities, conditions, which could, if ignored lead to machine damage or future hazardous situations. It is also used to alert the reader to pay careful attention to a particular passage of text in the manual.

Notes:

Notes are used to provide special information or helpful hints to assist in aerial platform operation, but do not indicate a hazardous situation.

■ Operation

The S3970RT / S3370RT / S2770RT aerial platform has built in safety features and has been factory tested for compliance with Snorkel specifications and industry standards. However, any personnel lifting device can be potentially dangerous in the hands of untrained or careless operators.

Training is vitally important and must be performed under the direction of a qualified person. You must display proficiency in knowledge and actual operation of the machine before using it on a job site.

Before operation of the machine you must read and understand the operating instructions in this manual as well as the decals, warnings and instructions on the machine itself.

Before operating the machine you must be authorised by the person in charge to do so and the operation of the machine must be within the scope of the machine specifications.

WARNING

The potential for an accident increases when the aerial platform is operated by personnel who are not trained and authorised. Death or serious injury can result from such accidents.

Read and understand the information in this manual and the placards and decals on the machine before operating the machine on the job site.

■ Maintenance

Every Person who maintains, inspects, tests or repairs these machines, and every person supervising any of these functions, must be properly trained and qualified to do so.

The Operators Manual provides a daily inspection procedure that will help you keep your S3970RT / S3370RT / S2770RT in good operating condition.

Do not perform other maintenance unless you are a trained mechanic, qualified to work on the S3970RT / S3370RT / S2770RT. Call qualified maintenance personnel if you find problems or malfunctions.

Do not modify this machine without written approval from the Engineering Department of Snorkel. Modification may void the warranty, adversely affect stability, or affect the operational characteristics of the S3970RT / S3370RT / S2770RT.

■ Responsibilities of parties

It is imperative that all owners and users of the S3970RT / S3370RT / S2770RT read, understand, and conform to all applicable regulations. Ultimate compliance to OSHA regulations is the responsibility of the user and their employer.

IMPORTANT

It is imperative that all owners and users of the S3970RT / S3370RT / S2770RT read, understand and conform to all applicable regulations. Ultimate compliance to OSHA regulations is the responsibility of the user and their employer.

IMPORTANT

ANSI Standard A92.6 clearly identifies requirements of all parties who might be involved with Self-Propelled Elevating Work Platforms. Australian / NZ Standard 2550-10 also identifies the requirements of all parties who might be involved with Boom-Supported Elevated Work Platforms.

Note

It is the responsibility of the owner to ensure that the person operating the machine is provided with all the relevant information relating to standards and codes of practice applicable in their region.

■ In Summary

- Only trained and authorised operators should be permitted to operate the equipment.
- All manufacturers operating instructions and safety rules and all employers safety rules and all OSHA and other government safety rules should be strictly adhered to.

- Repairs and adjustments should be made only by qualified and trained maintenance personnel.
- No modification should be made to the equipment without prior written consent of the Snorkel Engineering Department.
- Make a pre-start inspection of the S3970RT / S3370RT / S2770RT at the beginning of each shift. A malfunctioning machine must not be used.
- Make an inspection of the workplace to locate possible hazards before operating the S3970RT / S3370RT / S2770RT.

■ Product Warranty

For full terms of your warranty policy please refer to the Repair Parts Manual, or check with your Snorkel distributor, or check the Snorkel website.

■ Additional Information

For additional information, contact your local dealer or Snorkel at:

Snorkel New Zealand
PO Box 1041
Levin 5510
New Zealand

Electrical Hazard

Electrical Hazard Warning	2
-------------------------------------	---

Introduction

Standard S3970RT/S3370RT/S2770RT Version III .	3
Options	3
Operation Manual	3
Photographs	3
Safety Alerts	3
Operation	4
Maintenance	4
Responsibilities of Parties	4
Product Warranty	5
Additional Information	5

1. Safety

Safe Operation	1-1
Electrocution Hazards	1-1
Pre-start Inspection	1-1
Workplace Inspection and Practices	1-1
Operation	1-2
Tipover and Falling Hazards	1-2
General Safety Precautions	1-3
Hydraulic System Precautions	1-3
Fire / Explosion Prevention	1-3
Engine and Fuel Handling Precautions	1-3
Batteries	1-4
Safety Placards and Decals	1-4
Safety Placards and Decals Location	1-4

2. Safety Devices

Safety Device Information	2-1
Emergency Stop Switches	2-1
At platform control box	2-1
At ground control box	2-1
Alarms	2-1
Lowering	2-1
High temperature	2-2
Low oil pressure	2-2
Alternator not charging	2-2
Drive (reverse)	2-2
Drive (forward)	2-2
Load Sensing System	2-2
Level sensor	2-2
Primary Fall Restraint System	2-2
Safety Prop	2-3
Swinging Gate	2-3
Safety Control	2-3
Bubble Level	2-3
Operator Horn	2-3
Stabilisers (Option)	2-4
Rough Terrain Scissor Interlock Tests	2-4
Enable switch	2-4

RCD / ELCB AC Outlet (Option)	2-4
Flashing Light	2-5
Fall Restraint Lanyard Anchor Points (Option)	2-5

3. Specifications

General Specifications Standard Machine S3970RT	3-1
General Specifications Standard Machine S3370RT	3-2
General Specifications Standard Machine S2770RT	3-3
Engine Data	3-4
DF752 (option)	3-4
D902	3-4
Machine Component Identification	3-5

4. Gauges

EZCal LCD Display	4-1
Water	4-1
Alternator	4-1
Oil Pressure	4-1
Hours	4-1
Work time	4-1
Total time	4-1
Engine Oil	4-1
Hydraulic Oil Level	4-1
Bubble level	4-2

5. Automatic Shut-offs and Circuit Breakers

Automatic Shut-offs	5-1
Level sensor	5-1
Engine Temperature	5-1
Engine oil pressure	5-1
Platform height vs drive speed	5-1
Dynamic brakes	5-1
Alternator not charging	5-1
Load sensing system	5-1
Stabilisers	5-2
Fuses	5-2
RCD / ELCB outlet (option)	5-2

6. Controls

Controls	6-1
Hydraulic Compartment	6-1
Ground Control Box	6-1
Platform Control Box	6-2

7. Daily Inspection and Maintenance

Daily Inspection and Maintenance Table	7-1
Rough Terrain Scissor Interlock Tests	7-2
Stabiliser locked out when platform not elevated test	7-2

Table of Contents

Elevation locked out when axles not stowed test	7-2
Elevation locked out when tilted test	7-2
Fuel Level	7-3
Fuel filter (diesel engines only)	7-3
Fuel Leaks	7-3
Engine Oil	7-3
Engine Coolant	7-4
Radiator Cap	7-4
Swinging Gate	7-4
Wiring Harnesses and Connectors	7-4
Battery Terminals	7-5
Battery fluid level	7-5
Hydraulic Oil Tank	7-5
Hydraulic tank cap	7-5
Hydraulic oil level	7-5
Hydraulic Oil Leaks	7-5
Tires and Wheels	7-6
Bolts and Fasteners	7-6
Structural Damage and Welds	7-6
Primary Fall Restraint System	7-7
Bubble Level	7-7
Guides, Rollers and Slides	7-7
Ground Controls	7-7
Flashing Light	7-8
Platform Controls	7-8
Emergency Lowering	7-8
RCD / ELCB (Option)	7-9
Safety Prop	7-9
Fall Restraint Lanyard Anchor Points (Option)	7-9
Non-Slip Tread Grip	7-9
Wrist Support	7-9
Operator Manual	7-9
Placards and Decals	7-10

8. Operation

Operating Procedures	8-1
Control Stations	8-1
Emergency Stopping	8-1
Operation Considerations	8-1
Operating From The Ground Control Box	8-2
Raising the platform	8-2
Operating From The Platform Control Box	8-2
Driving	8-4
Variable maximum drive speed	8-4
Ramp off	8-4
Raising the platform	8-5
Stabilisers	8-5
Operating The Stabilisers Manually	8-6
To set the stabilisers	8-6
To raise the stabilisers	8-6
Operating The Auto Level System	8-7
Setting the stabilisers automatically	8-7
Raising the stabilisers automatically	8-7
The Risk of Operating Scissor Lifts on Outriggers on Ramps and Slopes	8-7

Extending The Multi-Position Platform	8-8
---	-----

9. Emergency Operation

Emergency Operation Procedures	9-1
Emergency Stop	9-1
Emergency Bleed Down	9-1
Pushing / Towing	9-2

10. Stowing and Transporting

Stowing	10-1
To lock the machine	10-1
Transporting	10-1
Trailing	10-1
Securing to a transport vehicle	10-2
Towing	10-3
Lifting	10-3
Pushing	10-3
Winching procedure	10-3
Long Term Storage	10-3

11. Options

Bi-Energy Option	11-1
DC motor	11-1
DC motor operation	11-1
Master battery isolator switches	11-1
Batteries	11-2
Battery charger	11-2
Batteries - general maintenance	11-3
Batteries - charging	11-3
Gasoline / LPG Fuel Option	11-3
Fuel level	11-3
LPG tank gauges and fuel level	11-3
Operating From The Ground Control Box	11-4
Operating From The Platform Control Box	11-5
RCD / ELCB Outlet	11-6
Fall Restraint Lanyard Anchor Points (Option)	11-6
Electrical Outlet	11-7
Non-Marking Tyres	11-7
Alternative Power Options	11-7
Stabilisers	11-7

12. Fire Fighting and Chemical Containment

Hazardous Components	12-1
Antifreeze (UN 1993)	12-1
Battery lead / acid (UN 2794)	12-1
Diesel fuel (NA 1993)	12-1
Foam in tyres	12-2
Gasoline (UN 1203)	12-2
Hydraulic oil (UN 1270)	12-3
Liquefied petroleum gas (UN 1075)	12-3
Motor oil (UN 1270)	12-3

13. Operator's Troubleshooting

Troubleshooting 13-1
Operators troubleshooting chart 13-1

Appendix A. Glossary

■ Safe Operation

Knowledge of the information in this manual, and proper training, provide a basis for safely operating the S3970RT / S3370RT / S2770RT. Know the location of all the controls and how they operate to act quickly and responsibly in an emergency.

Safety devices reduce the likelihood of an accident. Never disable, modify or ignore any safety device. Safety alerts in this manual indicate situations where accidents may occur.

If any malfunction, hazard or potentially unsafe condition relating to capacity, intended use or safe operation is suspected, stop the operation of the S3970RT / S3370RT / S2770RT and seek assistance.

The operator bears ultimate responsibility for following all manufacturers instructions and warnings, regulations and safety rules of their employer and/or any country or regional law.

■ Electrocutation Hazards

The S3970RT / S3370RT / S2770RT is an all metal aerial work platform and is not electrically insulated. Do not operate it near electrical conductors. Regard all conductors as being energised. Do not operate outside during a thunderstorm.

■ Pre-start Inspection

At the start of each work shift, the S3970RT / S3370RT / S2770RT shall be given a visual inspection and function test. See the Daily Inspection and Maintenance chapter in this manual for a list of items to inspect and test.

WARNING

DO NOT operate the S3970RT / S3370RT / S2770RT unless you are trained and authorised, understand the operation characteristics of the machine and have inspected and tested all functions to be sure they are in proper working order.

■ Work Place Inspection and Practices

Do not use the S3970RT / S3370RT / S2770RT as a ground for welding, Ground to the work piece.

Before the S3970RT / S3370RT / S2770RT is used, and during use, check the area in which the machine is to be used for possible hazards such as:

- Drop offs or holes
- Side slopes
- Bumps and floor obstructions
- Debris
- Overhead obstructions & electrical conductors
- Hazardous locations
- Inadequate surface and support to withstand all load forces imposed by the aerial platform in all operating configurations
- Wind and weather conditions
- Presence of unauthorised persons
- Other possible unsafe conditions

Before the S3970RT / S3370RT / S2770RT is used, determine the hazard classification of any particular atmosphere or location according to ANSI/NFPA 505-1987.

Any S3970RT / S3370RT / S2770RT operated in a hazardous location must be approved and of the type required by ANSI/NFPA 505-1987.

While operating the S3970RT / S3370RT / S2770RT a recommended safety practice is to have trained and qualified personnel in the immediate work area of the machine to:

- Help in case of an emergency
- Operate emergency controls as required
- Watch for loss of control by platform operator
- Warn the operator of any obstructions or hazards that may not be obvious to them
- Watch for soft terrain, sloping surfaces, drop offs, etc, where stability could be jeopardized
- Watch for bystanders and never allow anyone to be under, or to reach through the booms while operating the aerial platform.

DANGER

Pinch points may exist between moving components. Death or Serious injury can result from becoming trapped between components, buildings, structures or other obstacles. Make sure there is sufficient clearance around the machine before moving the chassis, booms or platform. Allow sufficient room and time to stop movement to avoid contact with structures or other hazards.

Keep ground personnel from under the platform when the platform is raised.

Secure all accessories, containers, tools and other materials in the platform to prevent them from accidentally falling or being kicked off the platform.

1. Safety

Always look in the direction of travel. Drive with care and at speeds compatible with the workplace conditions. Use caution when driving over rough ground, on slopes, and when turning.

Do not engage in any form of horse play or stunt driving while operating the S3970RT / S3370RT / S2770RT and do not permit riders on the machine any place other than on the platform.

Remove all loose objects stored in or on the machine, particularly in the platform. Remove all objects which do not belong in or on the machine.

Never steady the platform by positioning it against another platform.

Do not operate an S3970RT / S3370RT / S2770RT that is damaged or not functioning properly. Do not use the S3970RT / S3370RT / S2770RT until the machine has been repaired by a qualified maintenance person.

Do not operate a S3970RT / S3370RT / S2770RT that does not have all its decals and placards attached and legible.

Watch for bystanders and never allow any one to be under, or to reach through, the machine and its equipment while operating.

Use the recommended transport device when loading the machine.

■ Operation

ENSURE that you wear appropriate PPE while using the machine. The required PPE will vary depending on the specific job. A risk and hazard analysis must be performed by the operator to understand what PPE will be required.

DO NOT operate the machine if you feel tired, sick or if you are under the influence alcohol, prescription or illicit drugs.

If you encounter any suspected malfunction of the aerial platform, or any hazard or potentially unsafe condition relating to capacity, intended use or safe operation, cease operation immediately and seek assistance from management.

Use three (3) points of support when getting on or off the platform (two (2) hands and one (1) foot or a similar set of points). Keep the platform clean.

Maintain a firm footing on the platform floor. Operate the controls slowly and deliberately to avoid jerky and erratic operation. Always stop the controls in neutral before going in the opposite direction.

Do not dismount while the platform is in motion or jump off the machine. Do not start until all personnel are clearly away from the machine.

Never cover the floor grating or otherwise obstruct your view below. Make sure the area below the platform is free of personnel before lowering.

Access and egress from the platform is to be attempted ONLY when the platform is fully lowered.

DO NOT overload the platform by lifting additional equipment from an elevated platform.

The S3970RT / S3370RT / S2770RT is not intended for on-road use. The machine may be used on the road if applicable control measures are in place and local regulations are adhered to. Operators of the S3970RT / S3370RT / S2770RT MUST NOT push or pull objects with the platform.

■ Tipover and Falling Hazards

Operate the machine only on a firm, flat level surface capable of withstanding all load forces imposed by the S3970RT / S3370RT / S2770RT in all operating conditions.

DANGER

The machine can tip over if it becomes unstable. Death or serious injury can result from a tip over accident. Do not drive or position the S3970RT / S3370RT / S2770RT platform for elevated use near any drop-offs, hole, slope, soft or uneven ground, or other tip-over hazard.

Do not operate the machine from a position on trucks, trailers, railway cars, floating vessels, scaffolds or similar equipment unless the application is approved in writing by Snorkel.

Care shall be taken to prevent rope, electrical cords and hoses etc from becoming entangled in the aerial platform. If the platform or elevating assembly becomes caught, snagged or otherwise prevented from normal motion by an adjacent structure or other obstacle such that control reversal does not free the platform, remove all personnel from the platform before attempts are made to free the platform using ground controls.

No person shall access or egress from the platform in the elevated position (except in an emergency) unless the requirements of AS2550.10 have been met. For full requirements refer directly to AS2550.10.

Do not exceed the restricted platform capacity as indicated on the capacity placard at the entrance to the platform. Do not carry loads from any point outside of the platform.

Make sure that all protective guards, cowlings and doors are in place and secure. Be sure the guard rail system, including the gate, is in place and secure.

Do not climb on the guardrails or use ladders, planks or other devices to extend or increase your work position from the platform.

Do not use the machine as a crane, hoist or jack, or for any other purpose other than to position personnel, their tools and materials.

Do not operate the machine in winds, or wind gusts of 28 mph, 45 km/h 12.5 m/s or more.

DANGER

Do not add banners, flags, screens or shelters etc to areas of the S3970RT / S3370RT / S2770RT that are exposed to wind forces as this will increase the wind loading and effect stability.

■ General Safety Precautions

Do not modify the S3970RT / S3370RT / S2770RT in any way.

When parts or components are replaced, they shall be identical or equivalent to original Snorkel parts or components.

Do not override any of the safety features of the S3970RT / S3370RT / S2770RT. Ensure that the machine is secure from any unauthorised use.

■ Hydraulic System Precautions

The hydraulic system contains hoses with hydraulic fluid under pressure.

DANGER

Hydraulic fluid escaping under pressure can have enough force to inject fluid into the flesh. Serious infection or reaction can result if medical treatment is not given immediately. In case of emergency by

escaping hydraulic fluid, seek medical attention at once.

DO NOT place your hand or any part of your body in front of escaping hydraulic fluid. Use a piece of cardboard or wood to search for hydraulic leaks.

Do not attempt repairs to hydraulic systems unless you are trained. Refer to experienced repair personnel for help.

■ Fire / Explosion Prevention

Never operate your S3970RT / S3370RT / S2770RT near a flame or spark. Hydraulic oil and gasoline are flammable and can explode.

DO NOT operate the machine in an explosive environment unless the machine is suitably modified by an authorised agent of the manufacturer.

DO NOT carry fuel or other flammable or explosive or toxic substances in the platform unless a risk and hazard analysis shows that it is safe to do so and that applicable control measures are in place e.g. carry only the minimum amount required and in approved containers etc.

■ Engine and Fuel Handling Precautions

Engine exhaust contains carbon monoxide, a poisonous gas that is invisible and odorless. Breathing engine exhaust fumes can cause death or serious illness. Do not run the engine in an enclosed area or indoors without adequate ventilation.

Only refuel your machine outdoors in a clear area void of gas fumes or spilled gas. Never remove the fuel cap or refuel a gasoline engine while the engine is running or hot. ALWAYS allow the engine to cool before refueling. Never allow fuel to spill on hot machine components.

CAUTION

DO NOT smoke or permit open flames while fueling or near fueling operations.

Maintain control of the fuel filter nozzle when filling the tank.

WARNING

ENSURE you use an approved fuel container with appropriate fuel filter nozzle.

Do not fill the tank to capacity. Allow room for expansion.

1. Safety

If gasoline is spilled, clean up the spilled fuel immediately, push/tow the S3970RT / S3370RT / S2770RT away from the area of the spill and avoid creating any source of ignition until the spilled fuel has evaporated.

Tighten the fuel tank cap securely. If the fuel cap is lost, replace it with an approved fuel cap from Snorkel. Use of a non-approved cap without proper venting may result in pressurization of the tank.

Never use fuel for cleaning purposes.

For diesel engines, use the correct fuel grade for the operating season.

■ Batteries

Charge batteries in a well ventilated area free of flame, sparks or other hazards that might cause fire or explosion.

WARNING

Batteries give off hydrogen and oxygen that can combine explosively. Death or serious injury can result from a chemical explosion. Do not smoke or permit open flames or sparks when checking batteries.

Battery acid can damage the skin and eyes. Serious infection or reaction can result if medical treatment is not given immediately. Wear face and eye protection when working near batteries.

Batteries contain sulfuric acid that can damage your eyes or skin on contact. Wear a face shield, rubber gloves and protective clothing when working around batteries. If acid contacts your eyes, flush immediately with clear water and get medical attention. If acid contacts your skin, wash off immediately with clear water.

■ Safety Decals and Placards

There are several safety decals and placards on the S3970RT / S3370RT / S2770RT. Their locations and descriptions are shown in this section. Take time to study them.

CAUTION

Be sure that all the safety decals and placards on the S3970RT / S3370RT / S2770RT are legible. Clean or replace them if you cannot see the pictures. Clean with soap & water and a soft cloth. Do not use solvents.

You MUST replace a decal or placard if it is damaged, missing or cannot be read. If it is on a part that is replaced, make sure a new decal or placard is installed on the replaced part. See your Snorkel dealer for new decals and placards.

Note:

From time-to-time certain snorkel decals may be deleted, altered or replaced, or new decals may be added in line with new safety regulations or machine specification changes.

If you are unsure or want to check a particular decal or its placement on the machine contact your nearest Snorkel dealer or the Snorkel website.

■ Safety Placards and Decals Location

LEFT HAND SIDE OF THE MACHINE

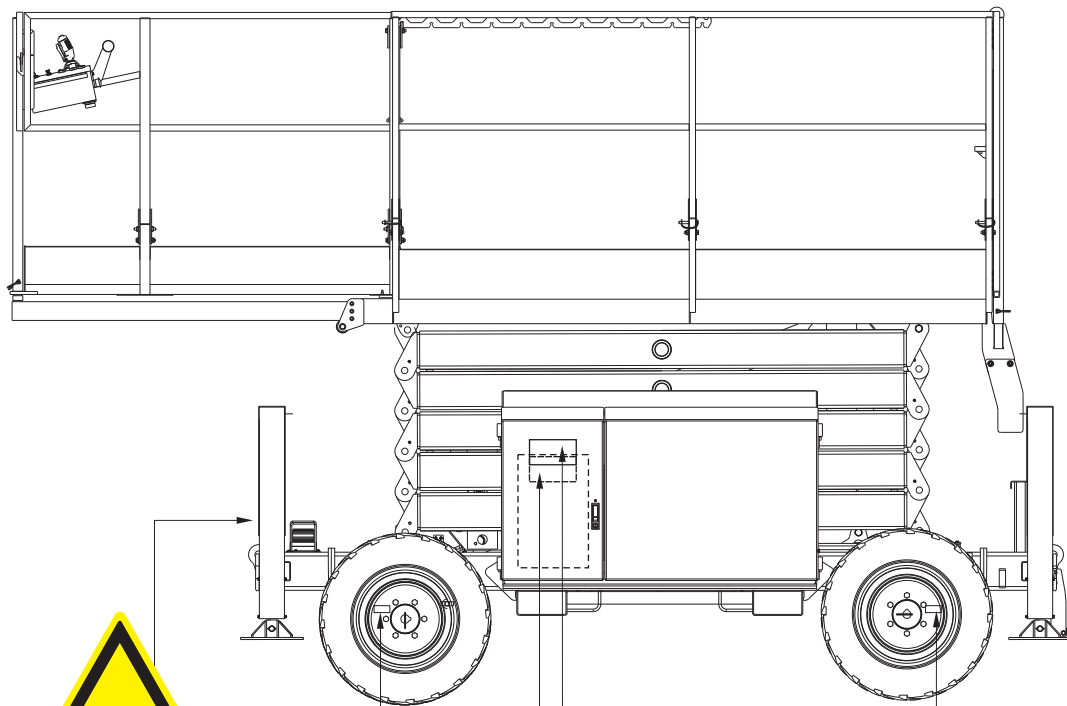

501453-000
All 4 Stabilisers

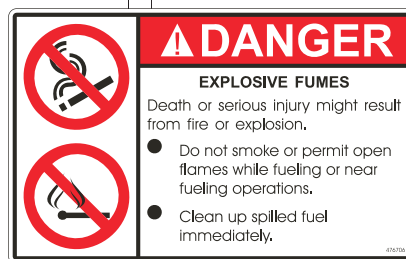

On Fuel Tank Inside Cabinet &
Outside Of Cabinet Door

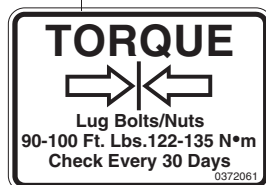

1. Safety

RIGHT-HAND SIDE OF MACHINE



⚠ DANGER
SHEARING HAZARD/CRUSHING HAZARD
 Death or serious injury might result from having body parts sheared or crushed as the platform descends. Keep away from closing scissor arms and keep out from under the platform as the platform comes down.

EMERGENCY OPERATION

1. EMERGENCY LOWERING
 In the event of total power failure pull the emergency lowering handle mounted at the front of the chassis until the platform starts to descend. Once the platform is lowered the handle can be released.

⚠ DANGER
 A runaway SR can cause Death or serious injury. Do not proceed unless the SR is on a level surface or is attached to an object that can hold the SR on a slope.

⚠ CAUTION
 The SR Drive motors will be ruined if the SR is pushed or towed faster than 3.2 kph (2 mph).

In order to push or tow the SR the following steps MUST be taken.

Freeheel the Front Drive Motors
 Turn the FREEWHEEL knob Counterclockwise fully.

Freeheel the Rear Drive Motors and Release the Brakes
 At the rear drive wheels, remove the two bolts from the disconnect plate. Turn the plate over so the ripple points inward. Reinstall the two bolts.

After the SR has been pushed or towed the Brakes and the Drive Motors MUST be re-set.
 To re-set the brakes turn the FREEWHEEL knob clockwise fully. At the rear drive wheels remove the two bolts from the disconnect plate. Turn the plate over so the ripples point outward. Reinstall the two bolts.

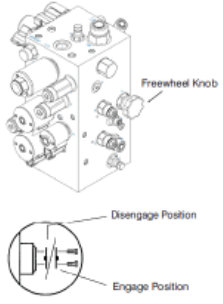

Freeheel Knob
 Disengage Position
 Engage Position

15170 Rev A

⚠ DANGER

YOU MUST NOT OPERATE THIS DEVICE UNLESS:

1. YOU HAVE BEEN TRAINED IN THE SAFE OPERATION OF THIS DEVICE AND
2. YOU KNOW AND FOLLOW THE SAFETY AND OPERATING RECOMMENDATIONS CONTAINED IN THE MANUFACTURER'S MANUALS, YOUR EMPLOYER'S WORK RULES, AND APPLICABLE GOVERNMENTAL REGULATIONS.

AN UNTRAINED OPERATOR SUBJECTS HIMSELF AND OTHERS TO DEATH OR SERIOUS INJURY.

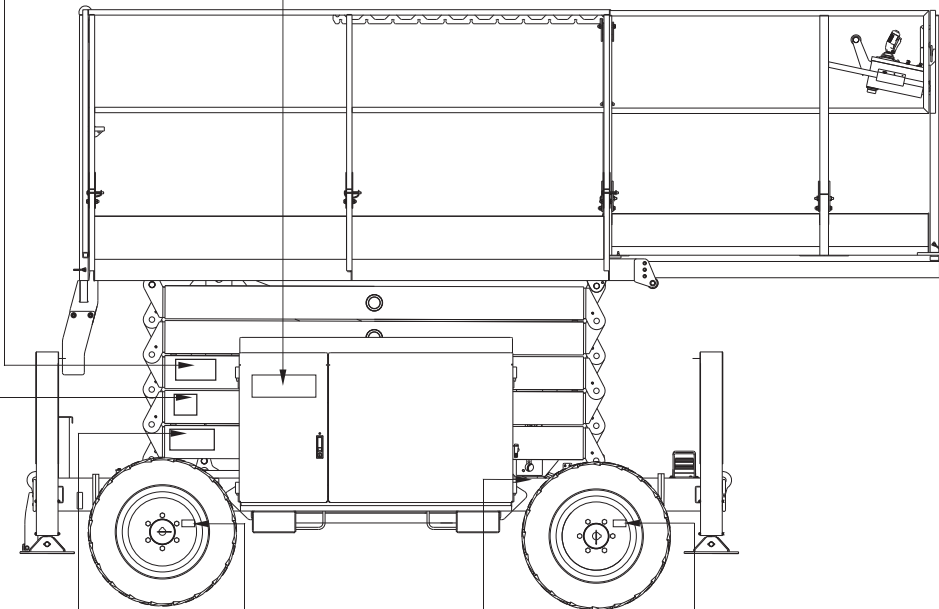

TORQUE



Lug Bolts/Nuts
 90-100 Ft. Lbs. 122-135 N*m
 Check Every 30 Days

⚠ DANGER
 DO NOT ALTER OR DISABLE LIMIT SWITCHES, SAFETY SWITCHES, OR INTERLOCKS.

⚠ DANGER

DEATH OR SERIOUS INJURY MAY RESULT IF SAFETY BAR IS NOT USED AND OR PROPERLY POSITIONED. USE SAFETY BAR AT ALL TIMES WHEN SERVICING MACHINE WITH PLATFORM RAISED.

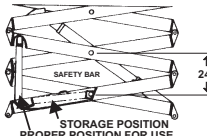

SAFETY BAR
 STORAGE POSITION
 PROPER POSITION FOR USE

PROPER USE OF SAFETY BAR

- * REMOVE ALL MATERIAL FROM PLATFORM
- * RAISE PLATFORM UNTIL THE OPEN HEIGHT BETWEEN CENTER PINS IS APPROXIMATELY 24 INCHES.
- * SWING SAFETY BAR UP FROM STORAGE POSITION.
- * REMOVE HANDS AND ARMS FROM SCISSORS AREA.
- * LOWER PLATFORM UNTIL SCISSORS ARE SUPPORTED BY SAFETY BAR.

TO STORE SAFETY BAR

- * RAISE PLATFORM UNTIL THE OPEN HEIGHT BETWEEN CENTER PINS IS APPROXIMATELY 24 INCHES.
- * SWING BAR DOWN TO STORAGE POSITION.

TORQUE



Lug Bolts/Nuts
 90-100 Ft. Lbs. 122-135 N*m
 Check Every 30 Days

FRONT END OF THE MACHINE

Clearance Requirements for Operating Non-Insulated Mobile Plant Including Elevating Work Platforms Near Power Lines While in Operating Mode

EWPA
Overhead Power Lines on Poles
Overhead Power Lines on Towers

Special Provisions

No.1 Notify the power authority before commencing work.
 No.2 Obtain written permission from the power authority.
 No.3 DO NOT commence work until a permit (which may include a risk assessment) has been completed.

Note: These special provisions are not applicable to work on or adjacent to conductors in the 0-100V supply range.

Australia Only

WARNING
KEEP CLEAR OF POWER LINES
 Unless the Electrical Supply Authority has advised in writing otherwise, the clearance between any live overhead power line and any part of this machine or load carried is required by law to be **AT LEAST 4 METRES**.
 This is a requirement of regulation 93 of the Electrical Supply Regulations 1984 in the interests of safe working.

New Zealand Only

⚠ DANGER

DEATH OR SERIOUS INJURY CAN RESULT FROM TIPPING OVER. TO KEEP FROM TIPPING THIS MACHINE OVER FOLLOW THESE RULES.

DO NOT RAISE OR DRIVE AN ELEVATED PLATFORM ON A SLOPE

DO NOT RAISE OR DRIVE AN ELEVATED PLATFORM ON SOFT OR UNEVEN SURFACES

GO NO CLOSER THAN 4 feet (1.2m) TO ANY DROP OFF OR HOLE

DO NOT RAISE A PLATFORM IN WIND ABOVE 28 MPH (12.5 M/S)

OTHER ACTIONS CAN ALSO CAUSE THIS MACHINE TO TIP OVER

- DO NOT override safety devices.
- DO NOT overload the machine.
- DO NOT stand or sit on guardrails.
- DO NOT attach ropes or chains to guardrails.
- DO NOT carry loads outside the railing or use as a crane.

DO NOT ride platform while machine is on a truck, fork lift or other device.

DO NOT use ladder, scaffold, or other means to increase size or platform height.

DO NOT use with improperly inflated or damaged tires or wheels.

TWO-TONE ALARM MEANS TIPOVER DANGER! LOWER PLATFORM IMMEDIATELY

1. [Icon of platform lowering]
2. [Icon of platform lowering]
3. [Icon of platform lowering]

TO AVOID TIPOVER HAZARDS USE ON FLAT, LEVEL, AND SOLID SURFACES ONLY

DO NOT use this machine without the railings and the entry gate in place. You could fall out and hurt or kill yourself.

DO NOT let an untrained or unauthorized person use this machine. When you leave the machine unattended, remove the key, or turn off the battery switch on the base of the machine and lock the battery switch in the off position.

DO NOT use this machine if it is not operating correctly, or if any part of it is damaged, worn, or missing. An accident could cause injury or death.

DO NOT replace components critical to machine stability, such as batteries and wheel equipment, with lighter

NOTE: STUDY THE OPERATOR'S MANUAL BEFORE OPERATING THIS MACHINE.

12574

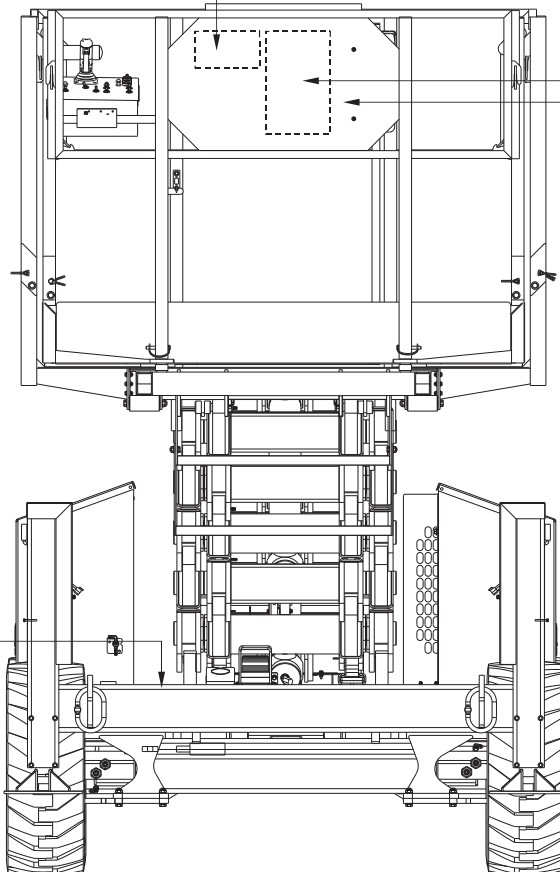

ALL DECALS ON REVERSE SIDE

← EMERGENCY BLEED DOWN VALVE

REAR END OF THE MACHINE

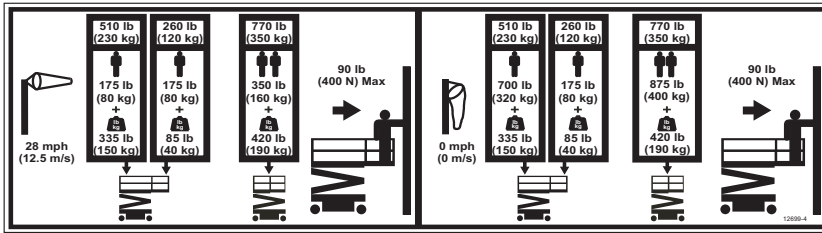

S3970RT

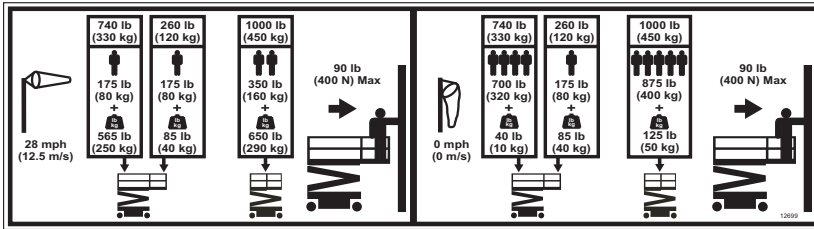

S3370RT

⚠ DANGER

- THIS UNIT IS EQUIPPED WITH FOAM FILLED TIRES, WHEEL WEIGHT IS CRITICAL FOR UNIT STABILITY.
- REPLACE WITH FACTORY APPROVED FOAM FILLED TIRES ONLY.
- DO NOT ATTEMPT TO INFLATE.

⚠ DANGER

DO NOT ALTER OR DISABLE LIMIT SWITCHES, SAFETY SWITCHES, OR INTERLOCKS.

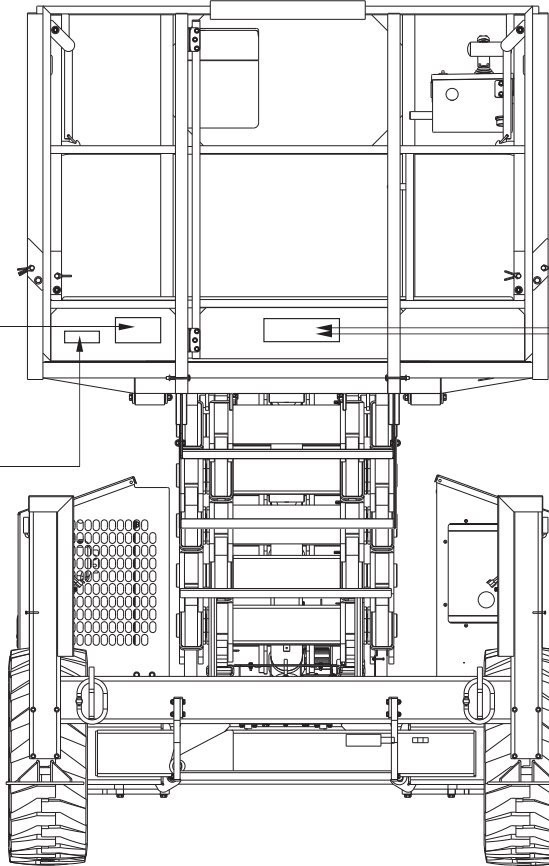

S2770RT

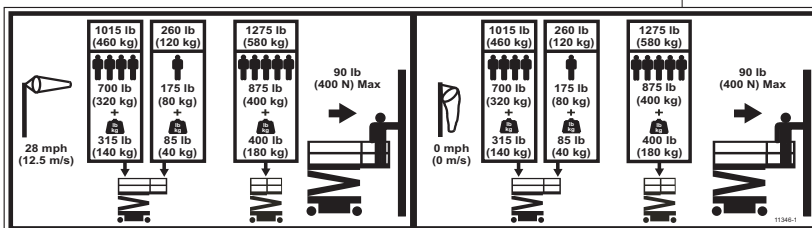

■ Safety Device Information

For emergency operation controls and procedures see the Emergency Operation, Chapter 9, in this manual.

The devices listed in this chapter are safety devices. They are on the machine to increase safety in the workplace for both the operator and other people near the machine.

⚠ WARNING

Do not bypass, disable, modify or ignore any of these devices. Check them carefully at the start of each work shift to see that they are in working order (see daily inspection & maintenance) chapter 7. If any is found to be defective, remove the S3970RT / S3370RT / S2770RT from service immediately until a qualified service technician can make repairs.

■ Emergency Stop Switches

□ At platform control box

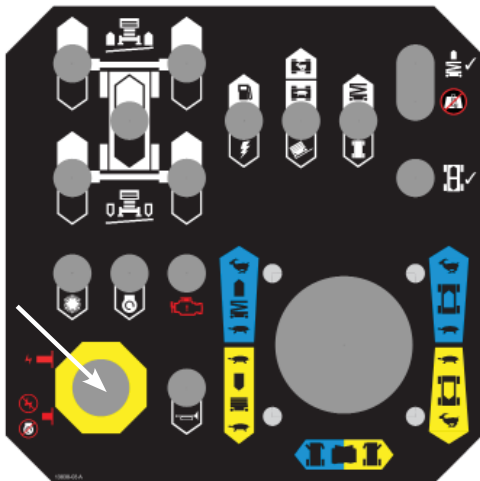

Figure 2.1 - Platform Control Box Emergency Stop Switch

Press the large red Emergency Stop button in and the entire machine stops, the engine turns off and nothing moves. This switch must be out (on) to control the S3970RT / S3370RT / S2770RT from the platform (pull the switch and it will pop out).

Push the emergency stop button inward when the upper controls are not in use to protect against un-intentional operation.

Note:

In order for the emergency stop switch at the platform to have an effect, the Platform/Ground key selector switch (on the lower control box) must be set to platform.

□ At ground control box



Figure 2.2 - Ground Control Box Emergency Stop Switch

Press the large red Emergency Stop button in and the entire machine stops, the engine turns off and nothing moves. the emergency stop switch must be out (on) for anything on the S3970RT / S3370RT / S2770RT to work (pull the switch and it will pop out).

Push the emergency stop button inward when the ground controls are not in use to protect against un-intentional operation.

■ Alarms

When an alarm occurs the buzzer in the lower control box will sound. The upper alarm will only sound if the upper controls are selected and active.

The different alarm sound patterns are shown in the table below.

	No oil Pressure No Alternator Charge High Water Temperature Overloaded
	Tilted and Elevated
	Axle Switch Open and Elevated
	Lowering or Forward Drive
	Reverse Drive

Figure 2.3 - Alarm Sound Patterns

□ Lowering

The lowering alarm warns people near the machine that the platform is coming down and the scissor arm assembly is closing.

Note:

When the alarm for either High Temperature, Low Oil Pressure, or Alternator Not Charging, the engine will automatically shut down after 20 seconds.

2. Safety Devices

□ High temperature

The high temperature alarm warns you that the engine is overheating. (See Automatic Shut-offs and Circuit Breakers chapter 5 for more information).

□ Low oil pressure

The low oil pressure alarm warns you that the engine oil pressure is near the lower limit for safe operation of the engine. (See Automatic Shut-offs & Circuit breakers chapter 5 for more information).

□ Alternator not charging

This alarm warns you that the alternator is not charging the battery. (See Automatic Shut-offs and Circuit Breakers chapter 5 for more information).

□ Drive (reverse)

The DRIVE (reverse) alarm alerts people that the S3970RT / S3370RT / S2770RT is traveling backwards along the ground. This alarm beeps twice as fast as the DRIVE (forward) alarm.

□ Drive (forward)

The DRIVE forward alarm alerts people that the S3970RT / S3370RT / S2770RT is traveling forward along the ground. The alarm beeps half as fast as the DRIVE (reverse) alarm.

■ Load Sensing System

As soon as the scissor stack rises from its stowed position the overload protection system becomes active.

- If **90%** of rated capacity is reached in the platform the overload light will illuminate.

This is a **warning** to the operator that the platform is reaching rated capacity. Normal function will remain and the machine can continue to be used.

- If **100%** of the rated capacity is reached in the platform the overload light will continue to be illuminated and an alarm will sound.

This is a **warning** to the operator that rated capacity has been reached and the platform load must be reduced. Normal function will remain to allow the platform to be positioned to remove some load from the platform.

Note:

The machine should not be operated continuously with the overload alarm sounding.

- if **110%** of rated capacity is reached in the platform the overload light will continue to be illuminated and an alarm will continue to sound and all functions will be disabled.

The operator **must remove load** from the platform.

Normal function will resume once the platform load has been reduced below 110% continuously for at least two (2) seconds.

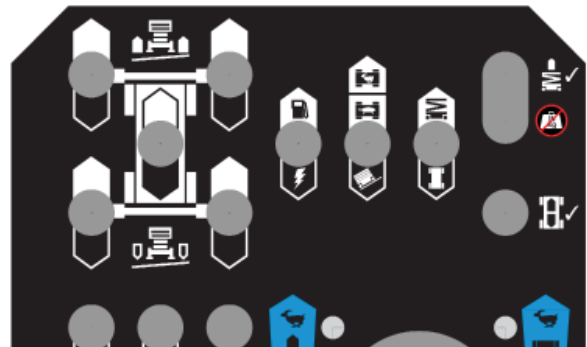

Figure 2.4 - Platform Overload Light

■ Level Sensor

The level sensor alarm warns the S3970RT / S3370RT / S2770RT operator that the machine is not level.

When you hear this alarm, immediately lower the platform completely down. When the platform is completely down, determine and correct the cause of the tilt before raising the platform again.

Note:

While the alarm is sounding it is not possible to drive the S3970RT / S3370RT / S2770RT nor raise the platform.

■ Primary Fall Restraint System



Figure 2.5 - Fall Restraint

The handrails, including mid-rail and toe board combined with the gate, form a Fall Restraint System. The System Prevents the operator from reaching the Fall Hazard. Ensure that all handrails are located correctly with each other and that all pins and bolts are in place.

If any part of the Fall Restraint System is not in place the System is compromised and the operator must review the Risk and Hazard analysis and determine ways to provide adequate fall protection e.g. the use of Fall Restraint Harnesses, Lanyards and Anchors.

■ Safety Prop



Figure 2.6 - Safety Prop

Always raise the safety prop then lower the scissor arm assembly onto the safety prop before reaching into the scissor arm assembly for any reason.

■ Swinging Gate

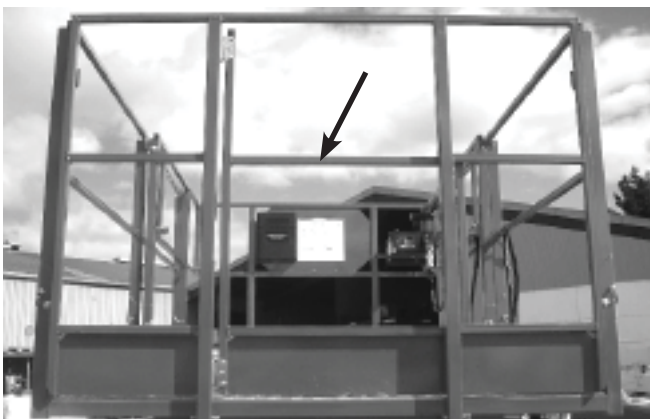

Figure 2.7 - Swinging Gate

The swinging gate should be closed all times except when someone is entering or leaving the platform.

■ Safety Control

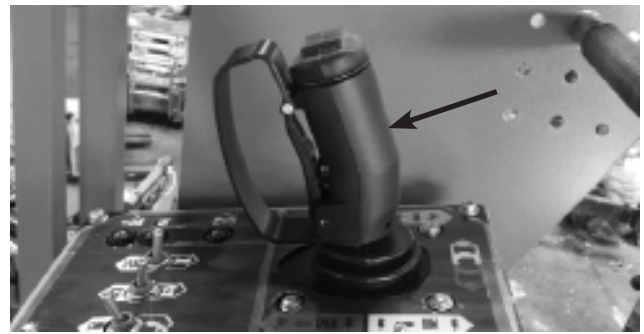

Figure 2.8 - Joystick Safety Control

The safety control must be squeezed and held to activate the joystick. The safety control prevents the joystick from moving the platform if something accidentally pushes the joystick. Do not attempt to disable the safety control in any way.

■ Bubble Level

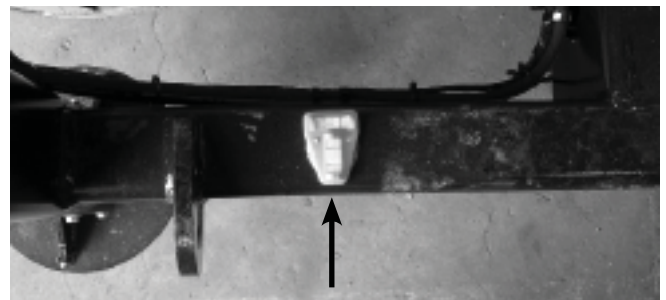

Figure 2.9 - Bubble Level

See the gauges chapter 4 for a discussion of the bubble level.

■ Operator Horn



Figure 2.10 - Operator Horn

The operator horn is used primarily to get the attention of people on the ground when you are working aloft. for the horn to work, the following switches on the ground control box, must be set as indicated.

2. Safety Devices

MAIN POWER.....ON
EMERGENCY STOP.....ON (up)
SELECTOR.....PLATFORM

■ Stabilisers (Option)



Figure 2.11 - Stabilisers

The stabiliser controls are on the upper left side of the platform control box. The stabilisers are used to level the S3970RT / S3370RT / S2770RT (for complete stabiliser operating procedures see the Operation chapter 8).

Note

The S3970RT / S3370RT / S2770RT must be on a firm surface capable of withstanding all load forces imposed by the aerial platform in all operation conditions before the stabilisers are used.

■ Rough Terrain Scissor Interlock Tests

All Snorkel scissor lifts in the Snorkel SRT, SR & S/RT series are fitted with a very important safety feature, a 'Stabiliser/axle/scissor Interlock' system that prevents the stabilisers being moved while the platform is elevated, and prevents the platform being raised if the rear axle is oscillated and the stabilisers are not set or the machine is tilted.

⚠ IMPORTANT

The correct operation of the stabiliser/scissor Interlock is critical to ensure that the Scissor is operated safely and with minimum risk.

Detailed instructions on how to carry out the tests to ensure that these functions are working correctly are provided at the beginning of the Pre-Operational Inspection chapter in this manual.

■ Enable Switch

The enable switch must be operated in conjunction with the platform moving function you select. The purpose of this switch is to prevent the platform from moving if something or someone accidentally pushes one of the platform moving controls.



Figure 2.12 - Enable Switch

■ RCD/ELCB Outlet (Option)

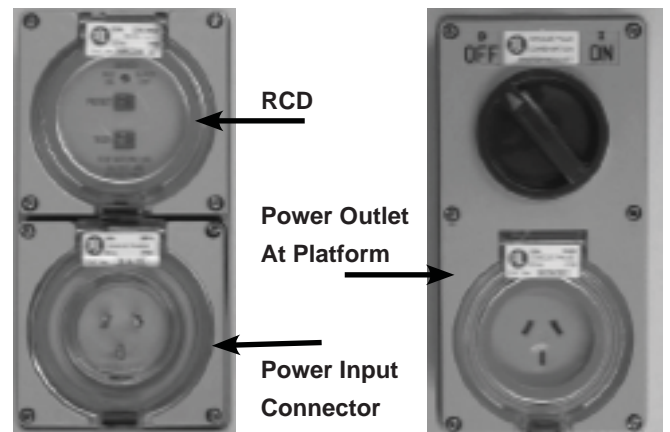

Figure 2.13 - RCD/ELCB AC Outlet

The RCD (Residual Current Device) is located at the ground and will protect against short circuits to earth. When there is a short circuit the RCD will shut down the 230V AC power to the platform outlet. To reset the outlet disconnect the power tool lead from the platform box and reset the RCD at the ground, if the problem persists call a trained service technician.

■ Flashing Light

The flashing light alerts people that the S3970RT / S3370RT / S2770RT is present and that the machine is moving. The light flashes at about one (1) flash per second any time the engine is running. There is no ON/OFF switch for the flashing light, it cannot be turned off while the S3970RT / S3370RT / S2770RT is running.

■ Fall Restraint Lanyard Anchor Points

There are three (3) Fall Restraint Anchor points on the floor of the platform on the S3970RT / S3370RT / S2770RT. Two (2) behind the roll-out deck when retracted, one (1) behind the roll-out deck when extended.

DANGER

The Fall Restraint Anchor points are rated for Fall Restraint only. A Fall Arrest System must not be attached. Death or serious injury could result from use of a Fall Arrest System.

The anchor points are positioned such that a Fall Restraint Lanyard can be set short enough to prevent the operator reaching the fall hazard (when not all guardrails are in place) while still allowing some freedom of movement.

Note:

These anchors are not for lifting or tying down the machine.

You should attach your fall protection to the anchors if work rules require it.

2. Safety Devices

■ General Specifications S3970RT

SPECIFICATIONS	S3970RT		S3970BE	
Nominal working height (wheels)	13.5m	44.2'	13.5m	44.2'
Nominal working height (stabilisers)	13.81	45.3'	13.81	45.3'
Roll out deck size	1.2m	48"	1.2m	48"
Drive speed (below 2.4m)	0 to 04.5km/h	0 to 2.8mph	0 to 04.5km/h	0 to 2.8mph
Drive speed (above 2.4m)	0 to 0.35kp/h	0 to 0.22mph	0 to 0.35kp/h	0 to 0.22mph
Safe working load - Main deck (Roll out deck not extended)	350kg	770lb	350kg	770lb
Safe working load - Main deck Safe working load - Roll out deck extended	230kg 120kg	510lb 260lb	230kg 120kg	510lb 260lb
Platform size	1.73 x 1.65m	8' 11" x 5' 5"	1.73 x 1.65m	8' 11" x 5' 5"
Stowed height	2.93m	9' 7"	2.93m	9' 7"
Stowed height (hand rails folded down)	2.10m	6' 11"	2.10m	6' 11"
Overall length	3.36m	11' 0"	3.36m	11' 0"
Overall width	1.80m	5' 11"	1.80m	5' 11"
Gradeability	30%		30%	
Lift time	50 seconds		50 seconds	
Turning radius (inner)	2.7m	8' 10"	2.7m	8' 10"
Turning radius (outer)	5.0m	16' 3"	5.0m	16' 3"
Maximum wind speed (12.5m/s)	45km/h	28mph	45km/h	28mph
Insulation rating	Nil		Nil	
Tyres - Poly filled loader lug	27" x 10.5" x 15"		27" x 10.5" x 15"	
Overall weight	3790kg	8355lb	4140kg	9127lb
Ground clearance	350mm	13.8"	350mm	13.8"
Maximum sound level at platform	86db		86db	
Stabiliser maximum load	2110kg	4652lb	2285kg	5039lb
Maximum chassis inclination	2.5°/4°		2.5°/4°	
Allowable manual force	400N		400N	
Tyre contact pressure (average)	879kPa	127psi	950kPa	138psi
Tyre contact pressure (worst)	1725kPa	250psi	1868kPa	271psi

3. Specifications

■ General Specifications S3370RT

SPECIFICATIONS	S3370RT		S3370BE	
Nominal working height	12.12m	39' 2"	12.12m	39' 2"
Roll out deck size	12.m	48"	12.m	48"
Drive speed (below 2.4m)	0 to 4.5kp/h	0 to 2.8mph	0 to 4.5kp/h	0 to 2.8mph
Drive speed (above 2.4m)	0 to 0.35kp/h	0 to 0.22mph	0 to 0.35kp/h	0 to 0.22mph
Safe working load - Main deck (Roll out deck not extended)	450kg	1000lb	450kg	1000lb
Safe working load - Main deck Safe working load - Roll out deck extended	330kg 120kg	740lb 260lb	330kg 120kg	740lb 260lb
Platform size	2.73 x 1.65m	8' 11" x 5' 5"	2.73 x 1.65m	8' 11" x 5' 5"
Stowed height	2.78m	9.12'	2.78m	9.12'
Stowed height (hand rails folded down)	1.95m	6.40'	1.95m	6.40'
Overall length	3.36m	11' 0"	3.36m	11' 0"
Overall width	1.80m	5' 11"	1.80m	5' 11"
Gradeability	35%		35%	
Lift time	50 seconds		50 seconds	
Turning radius (inner)	2.7m	8' 10"	2.7m	8' 10"
Turning radius (outer)	5.0m	16' 3"	5.0m	16' 3"
Maximum wind speed (12.5m/s)	45km/h	28mph	45km/h	28mph
Insulation rating	Nil		Nil	
Tyres - Poly filled loader lug	27" x 10.5" x 15"		27" x 10.5" x 15"	
Overall weight	3620kg	7981lb	3970kg	8752lb
Ground clearance	350mm	13.8"	350mm	13.8"
Maximum sound level at platform	86db		86db	
Stabiliser maximum load	2075kg	4580lb	2250kg	4962lb
Maximum chassis inclination	2.5°/4°		2.5°/4°	
Allowable manual force	400N		400N	
Tyre contact pressure (average)	865kPa	125psi	936kPa	136psi
Tyre contact pressure (worst)	1696kPa	246psi	1839kPa	267psi

■ General Specifications S2770RT

SPECIFICATIONS	S2270RT		S2270BE	
Nominal working height	10.28m	33' 9"	10.28m	33' 9"
Roll out deck size	1.2m	48"	1.2m	48"
Drive speed (below 2.4m)	0 to 4.5km/h	0 to 2.8mph	0 to 4.5km/h	0 to 2.8mph
Drive speed (above 2.4m)	0 to 0.9kp/h	0 to 0.6mph	0 to 0.9kp/h	0 to 0.6mph
Safe working load - Main deck (Roll out deck not extended)	580kg	1275lb	580kg	1275lb
Safe working load - Main deck Safe working load - Roll out deck extended	460kg 120kg	1015lb 260lb	460kg 120kg	1015lb 260lb
Platform size	2.73 x 1.65m	8' 11" x 5' 5"	2.73 x 1.65m	8' 11" x 5' 5"
Stowed height	2.61m	8' 7"	2.61m	8' 7"
Stowed height (hand rails folded down)	1.78m	5' 10"	1.78m	5' 10"
Overall length	3.36m	11' 0"	3.36m	11' 0"
Overall width	1.80m	5' 11"	1.80m	5' 11"
Gradeability	35%		35%	
Lift time	26 seconds		26 seconds	
Turning radius (inner)	2.7m	8' 10"	2.7m	8' 10"
Turning radius (outer)	5.0m	16' 3"	5.0m	16' 3"
Maximum wind speed (12.5m/s)	45km/h	28mph	45km/h	28mph
Insulation rating	Nil		Nil	
Tyres - Poly filled loader lug	27" x 10.5" x 15"		27" x 10.5" x 15"	
Overall weight	2886kg	6363lb	3236kg	7134lb
Ground clearance	350mm	13.8"	350mm	13.8"
Maximum sound level at platform	86db		86db	
Stabiliser maximum load	1773kg	3911lb	1948kg	4292lb
Maximum chassis inclination	3.5°/4°		3.5°/4°	
Allowable manual force	400N		400N	
Tyre contact pressure (average)	741kPa	107psi	813kPa	118psi
Tyre contact pressure (worst)	1449kPa	210psi	1592kPa	231psi

3. Specifications

■ Engine Data

Engine Make	Kubota		
Model	DF752 (Option)		D902
Fuel	gasoline	LPG	Diesel
Fuel grade	Unleaded 85 octane (motor method) Do not use gasoline blended with methyl alcohol.	HD5 Gas Processors Association Standard 2140 Category: special duty propane	ASTM Grade 2-D S5000 Tier 4 Compliance: Low Sulpher ASTM Grade 2-D S500 Centane number >44 (For operating temp. Below 32°F (0°C) use “winterized” number 2-D.)
Coolant	50% water + 50% ethylene glycol		
Maximum temperature	110°C		
Oil Capacity	3.7L		
Oil grade	API: Quality better than CD		
Oil weight	See chart below		

Engine Oil Charts

DF752 (Option)

Ambient temperature	Engine oil weight
Above 77°F (25°C)	SAE30 or 10W30
32°F to 77°F (0°C) to (25°C)	SAE20 or 10W30
0°F to 32°F (-17°C) to (0°C)	SAE10W or 10W30

D902

Ambient temperature	Engine oil weight
Above 77°F (25°C)	SAE30 or 10W30 10W40
32°F to 77°F (0°C) to (25°C)	SAE20 or 10W30 10W40
Below 32°F (0°C)	SAE10W or 10W30 10W40

NOTE:

For further details regarding lubricants, maintenance schedules and service please refer to the Maintenance and Repair Parts Manual for this machine.

■ Machine Component Identification

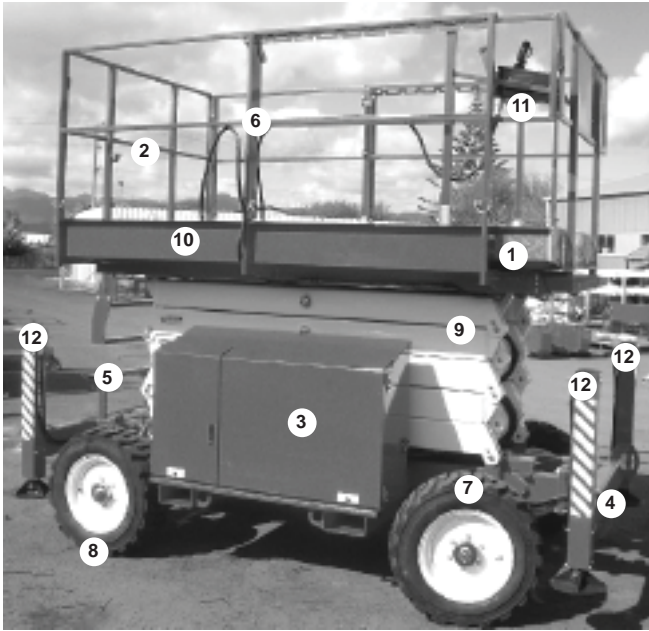

1. Extendable platform
2. Entry gate
3. Hydraulic compartment
4. Front end
5. Rear end
6. Guard rails
7. Steering (front) wheels
8. Rear wheels
9. Scissor arms
10. Platform
11. Platform control box
12. Stabilisers / outriggers (option)

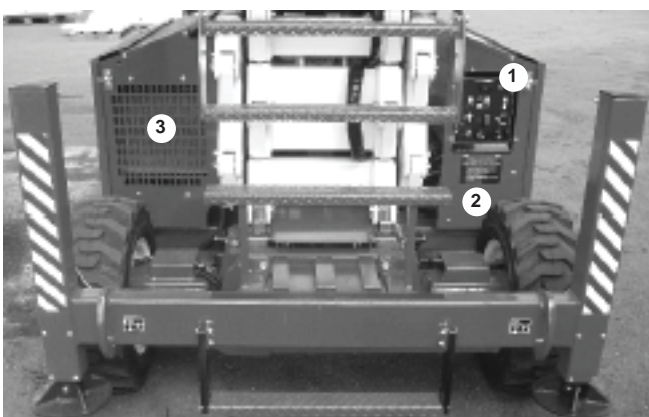

1. Base control panel
2. Serial number plate
3. Engine & fuel compartments

3. Specifications

■ EzCal LCD Display



Figure 4.1 - EzCal LCD Display

The EzCal LCD display is a diagnostic tool for the control system. It is intended to be used primarily by trained technicians.

The EzCal LCD display gives some information for the machine operator.

■ Water

If the engine becomes too hot the EzCal LCD display will show **“Shutdown - Engine Too Hot”**.

■ Alternator

If the alternator is not providing sufficient charge the EzCal LCD display will show **“Shutdown - Not Charging”**.

■ Oil Pressure

If the engine does not have sufficient oil pressure the EzCAL LCD display will show **“Shutdown - No Oil Pressure”**.

■ Hours

□ Work time

The EzCal default state is to display machine work time. It accumulates time whenever the control system is active. This can be reset by a qualified technician. This value can be used to tell when periodic maintenance is due.

□ Total time

The total machine on time can be found by using the EzCal diagnostics under log. This can not be reset.

■ Engine Oil

Engine oil is measured with a dipstick. Oil capacities given in the Specifications chapter 3 are approximate. True values will vary from machine to machine due to slight variations or modifications during production.

- The oil dipstick is the only way to accurately gauge if the engine oil is correct.
- Engine oil level should always be between the lines on the dipstick - never above the top line or below the bottom line.

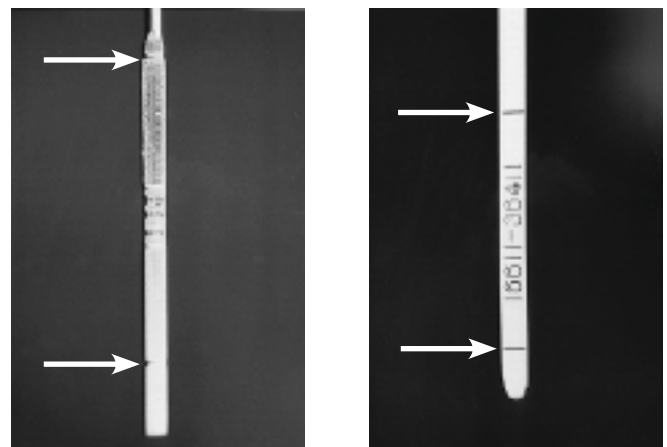

Figure 4.3 - Oil Dipstick Levels for Gasoline and Diesel Engines

■ Hydraulic Oil Level



Figure 4.4 - Hydraulic Oil Level

The hydraulic oil level gauge is on the side of the hydraulic oil tank. It shows the actual level of the oil inside the tank. Read it only when the platform is completely down. Otherwise, the lift cylinders become large reservoirs for hydraulic oil and the oil in the tank will be low. The oil level should be within (0.25 inches , 6.4 mm) of the line.

4. Gauges

Bubble Level

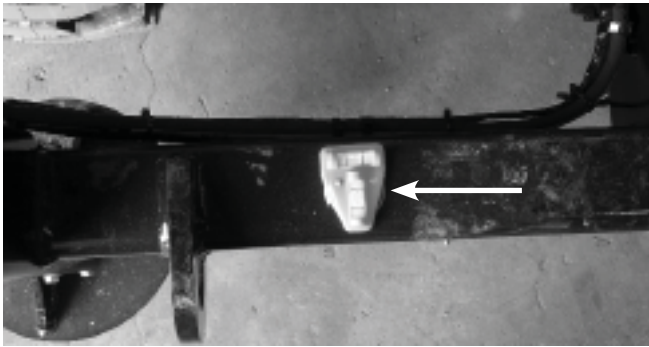

Figure 4.7 - Bubble Level

A bubble level is located on the platform side rail, below the platform control box. Watch the bubble level while you set the stabilisers manually. Lower the stabilisers, one at a time, just enough to set the bubble between the guidelines in both the fore and aft and lateral gauges. When the bubbles are centered the platform is level and can safely be raised.

5. Automatic Shut-offs and Circuit Breakers

■ Automatic Shut-offs

□ Level Sensor

When the level sensor alarm sounds, automatically interlocks make it impossible to drive the S3970RT / S3370RT / S2770RT or raise the platform. For more complete information see the Level Sensor subsection of the Safety Devices 2 chapter.

□ Engine temperature

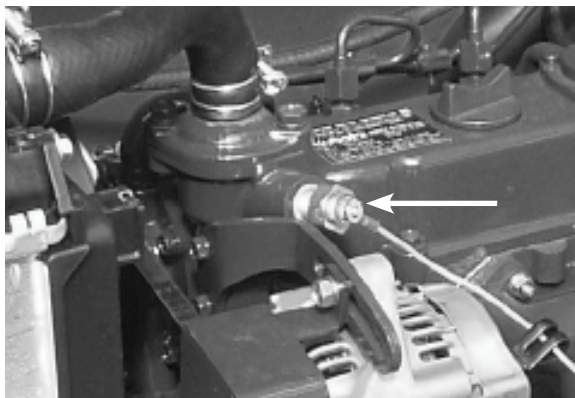

Figure 5.1 - Engine Temperature Sensor

There is a temperature sensor in the engine. It measures the temperature of the anti-freeze water mixture as the mixture leaves the top of the radiator and enters the top of the engine. If the temperature reaches 210(F) or 99(C) an alarm sounds. If the temperature continues to rise, the engine shuts off when the temperature reaches 230(F) or 110(C). The engine will not restart until the temperature drops below 210(F) or 99(C).

□ Engine oil pressure

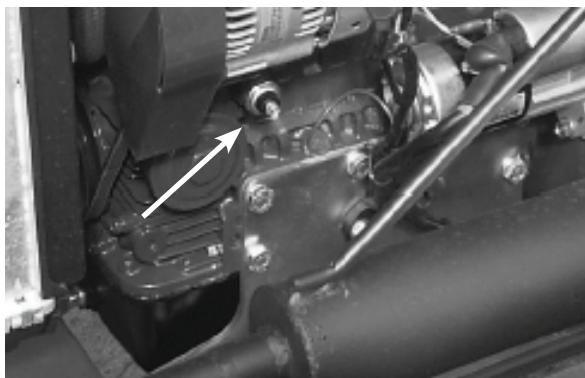

Figure 5.2 - Engine Oil Pressure Sensor

There is an oil pressure sensor in the engine. It measures the engine oil pressure at the oil filter. If the pressure falls below a safe operating value the engine shuts off. The engine will restart with low pressure but it will only run a few seconds before it automatically shuts off again.

□ Platform height vs. drive speed

The machines feature a variable maximum drive speed with height. As the elevation gets higher the drive speed reduces.

The speed change is automatic and requires no user intervention. Refer to the Operation chapter for more information.

□ Dynamic brakes

When you drive the machine down a slope, if the S3970RT / S3370RT / S2770RT begins to coast (outrun the drive motors) the hydraulic system senses the coasting condition. The hydraulic drive motors then become hydraulic brakes and the machine is slowed. This action prevents the S3970RT / S3370RT / S2770RT from speeding down grades.

□ Alternator not charging

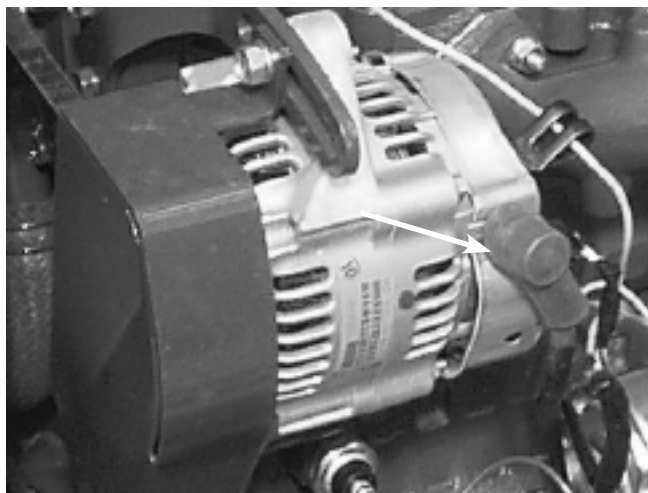

Figure 5.3 - Alternator Output Shutdown

If the fan belt breaks, or the alternator output falls below a safe level for other reasons, the engine automatically shuts off and an alarm sounds. As long as the S3970RT / S3370RT / S2770RT battery is charged you can lower the platform in the usual way from the platform control box or ground control box without the engine running.

□ Load sensing system

When the alarm sounds automatic interlocks prevent all platform movement: Drive forward / reverse and lift up / down. For more complete information see the load sensing subsection of the Safety Devices chapter 2.

5. Automatic Shut-offs and Circuit Breakers

□ Stabilisers

The S3970RT / S3370RT / S2770RT can not be driven unless the stabilisers are completely up. If you have just raised the stabilisers but the S3970RT / S3370RT / S2770RT will not drive, double check to be sure all four (4) stabilisers are completely up.

■ Fuses

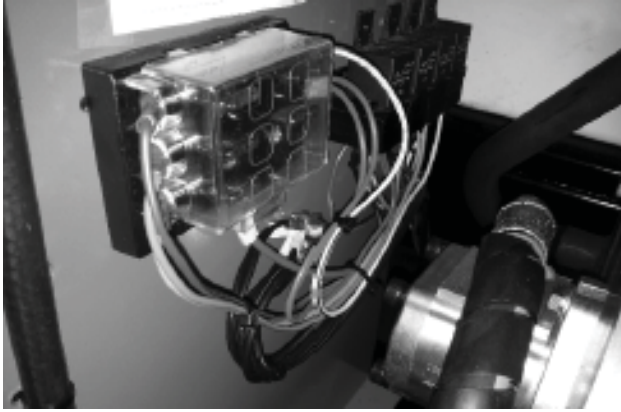

Figure 5.4 - Fuses

There are four (4) fuses on a standard S3970RT / S3370RT / S2770RT that are accessible to the operator. (The fuses are located on the engine cabinet wall under the radiator overflow bottle). The purpose is to protect the electrical circuits from overloads. If a fuse blows investigate the cause. When satisfied the fault no longer occurs replace the fuse with one of the same rating then attempt to use the S3970RT / S3370RT / S2770RT.

If the fuse blows again, take the S3970RT / S3370RT / S2770RT out of service and refer the problem to a trained service technician for repair.

□ RCD / ELCB outlet (option)

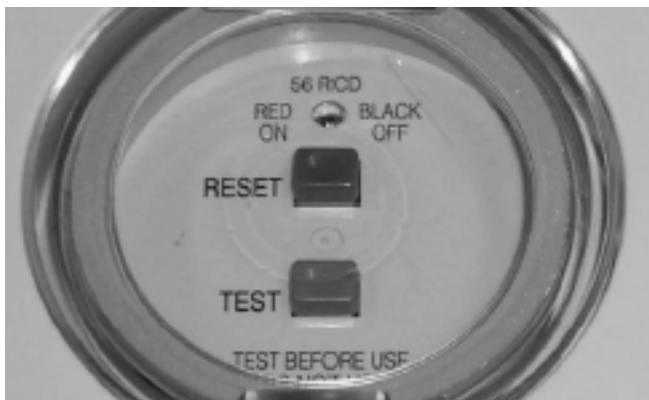

Figure 5.5 - RCD /ELCB Outlet

The RCD (Residual Current Device) is located at the ground and will protect against short circuits to earth. When there is a short circuit the RCD will shut down the 230V AC power to the platform outlet.

To reset the outlet disconnect the power tool lead from the platform box and reset the RCD at the ground.

If the problem persists call a trained service technician.

■ Controls

This chapter explains what each control does.

This chapter does not explain how to use the controls to produce useful work, refer to the Operation chapter 8 for that, after you have a read of this chapter.

For optional equipment controls, see the Options chapter 11.

See the Emergency Operation chapter 9 for the location of the emergency bleed down control and for correct emergency bleed down procedures.

The main operating functions of the machine can be controlled from the ground control box (1) or the platform control box (2).

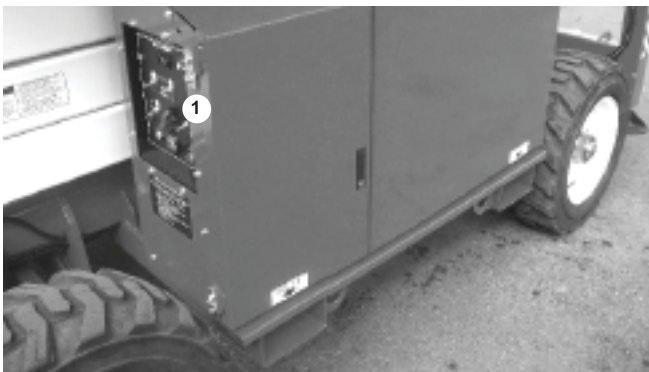

Figure 6.1.1 - Control Box Location, Ground Position



Figure 6.1.2 Control Box Location, Platform Position

■ Hydraulic Compartment

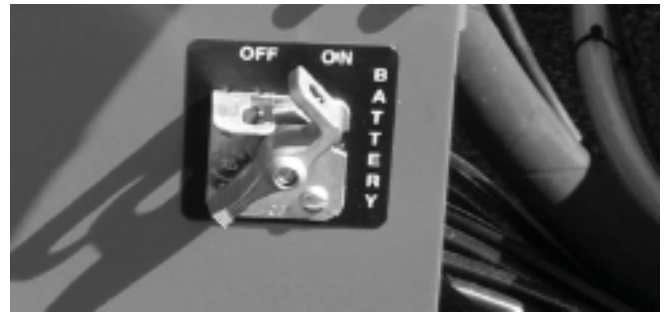

Figure 6.2 - Battery Switch

Battery Switch: This must be ON for the engine to start. When the battery switch is OFF, the positive side of the S3970RT / S3370RT / S2770RT battery is disconnected from the electrical system. Lock this switch OFF when the machine is left unattended.

■ Ground Control Box

Controls for operating the machine from the ground are located on the right side of the machine on the rear of the hydraulic compartment.

Note 1

The number of each control corresponds to figure 6.3.

Note 2

Some switches and indicators are either not used, or may serve a different purpose depending on the configuration of your machine.

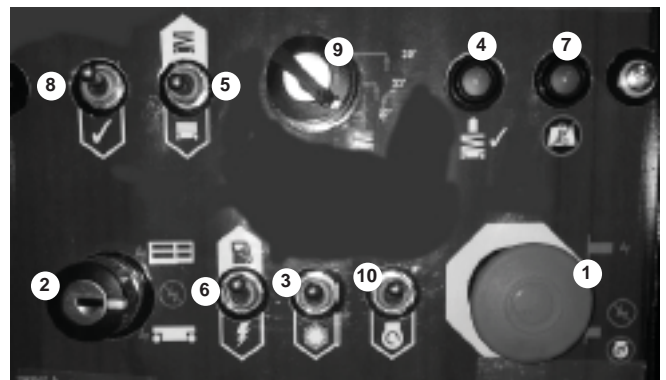

Figure 6.3 -Ground Control Box Controls

- 1. Emergency Stop:** Press the red button in at any time, under any conditions and the entire machine stops. The engine turns off and nothing moves. This switch must be out (on) to start and run the S3970RT / S3370RT / S2770RT, pull the switch and it will pop out (on). Push the emergency stop button inward when the ground controls are not in use to protect against un-intentional operation.

6. Controls

2. **Ground / Platform Key Switch:** Three position switch that selects between Ground, Off and Platform. The key is removable in the Off position only and is used to secure the machine from unauthorised use.

3. **Choke:** (Option gasoline engines only) Hold the choke switch down at any time you start a gasoline engine that is at ambient air temperature (a cold engine).

Glow Plug: (Diesel engines only) This is a momentary contact switch. Press it down and hold, for no longer than 20 seconds, then release it just before starting the engine for an engine that is at ambient air temperature (a cold engine).

4. **Lift Indicator Light:** The platform can be raised only when the light is lit. When this light is not lit the platform will not rise because the platform is not level or the stabilisers are not properly set.

5. **Platform Lift / Lower:** Holding this switch up causes the platform to rise. Pushing this switch down causes the platform to lower.

6. **Fuel (Option):** Before starting, set the FUEL switch to Fuel (up) or Electric (down) depending on your machine set up and which you want to use.

7. **Platform Overload Indicator Light:** All movement is prevented when this light is illuminated. The platform load must be reduced before the machine will operate.

8. **Enable Switch:** The enable switch must be operated in conjunction with the platform moving function you select. The purpose of the switch is to prevent the platform from moving if something or someone accidentally pushes one of the moving controls.

9. **Variable Height Lockout Key Switch: (not functional on the S2770RT):** Three position switch used to restrict the maximum elevation to 33ft or 27ft working height.

On the S3970RT the switch can be used to allow full height or limit the maximum elevation to 33ft or 27ft working height.

On the S3370RT the switch can be used to allow full height or limit the maximum elevation to 27ft working height.

10. **Start Switch:** Press and hold this switch DOWN to operate the starter motor of the machine.

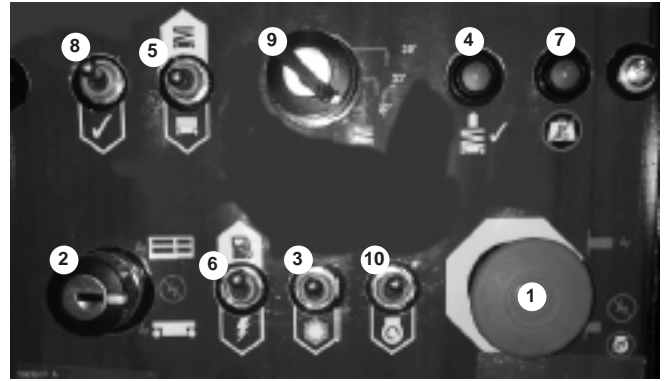

Figure 6.3 Ground Control Box Controls

■ Platform Control Box

Controls for operating the machine from the platform are located on the platform control box.

Note:

The number of each control corresponds to figure 6.4.

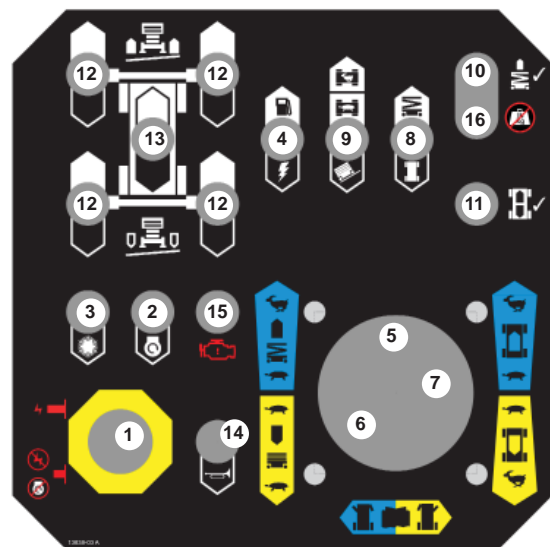

Figure 6.4 - Platform Control Box Controls

Note:

The EMERGENCY STOP switch on the ground control box overrides the one on the platform control box. If the one on the ground control box is off the S3970RT / S3370RT / S2770RT will not start or run.

Note:

When the platform / ground key selector switch is set to ground the ENTIRE platform control box is inoperative including the Emergency Stop.

- 1. Emergency Stop:** Press the red button in at any time, under any conditions, and the entire machine stops - the engine turns off and nothing moves. The switch must be out (on) to start and run the S3970RT / S3370RT / S2770RT from the platform control box, pull the switch and it will pop out (on). Press the switch in (off) if the platform is to stay in one position for a long time. That will turn the engine off and save fuel. Push the emergency stop button inward when the upper controls are not in use to protect against unintentional operation.
 - 2. Start:** Press and hold the switch to start the engine. As soon as the engine starts, release the switch.
 - 3. Choke:** (option gasoline engines only) press and hold the switch in anytime you start a gasoline engine that is at ambient air temperature (a cold engine).
Glow Plug: (diesel engines only) this is a momentary contact switch. Press it down and hold for no longer than 20 seconds then release it just before starting the engine for an engine that is at ambient air temperature (a cold engine).
 - 4. Fuel (Option):** Before Starting set the FUEL switch to Fuel (up) or Electric (down) depending on your machine set up and which you want to use.
 - 5. Safety Control:** The safety control must be squeezed against the joystick controller to activate the joystick controller. if the safety control is not squeezed, the joystick is inoperative.
 - 6. Joystick Controller:** If the LIFT / DRIVE selector is set to the lift function, pulling the joystick controller backward causes the platform to lower, pushing the joystick controller forward causes the platform to rise. If the LIFT / DRIVE selector is set to the drive function, pushing the joystick controller forward causes the S3970RT / S3370RT / S2770RT to move forward, pulling the joystick controller backward causes the machine to move backward. The further you push or pull the controller the faster the motion (except lowering it occurs at one speed only).
- Note**
Squeeze the safety control anytime you use the joystick controller.
- 7. Steering:** The rocker switch on top of the joystick controller turns the front wheels left or right depending on which side of the switch you press.
- Note:**
The wheels do not return to straight ahead after a turn, the way automobile wheels do. You must use the steering switch to straighten the wheels after a turn.
- 8. Lift / Drive Selector:** When this switch is set to lift, the joystick controller becomes a lift / lower controller to raise or lower the platform. When this switch is set to drive, the joystick controller becomes a throttle controller to drive the S3970RT / S3370RT / S2770RT forward or backward. The machine will not drive and lift at the same time.
 - 9. Speed:** Set the switch to turtle (slow) when you are working in close quarters or if you are new to the machine. Setting the switch to rabbit (fast) doubles the top speed of the S3970RT / S3370RT / S2770RT. Set the switch to Torque Mode when climbing steep surfaces or when you need maximum torque.
 - 10. Lift Indicator Light:** The platform can be raised only when this light is lit. When this light is not lit the platform will not rise because: the platform is not level, or the stabilisers are not set properly.
 - 11. Drive Indicator Light:** The platform can be driven when the light is lit. When it is not lit, the platform will not drive because with the platform raised the base is not level or with the platform raised the axle switches are not set.
 - 12. Stabiliser Manual Switches:** Each switch corresponds to one (1) of the stabilisers (if stabilisers are fitted) Pull a switch backward to lower a stabiliser, push it forward to raise the stabiliser.
 - 13. Auto Level / Stow Switch:** Select either auto level or auto stow, to raise or lower the stabilisers automatically (if stabilisers are fitted).
 - 14. Horn Switch:** Press the switch to operate the horn.
 - 15. Engine Warning Light:** This indicator light should go off when the engine is started. Stop the engine immediately if this light comes on when the engine is running.
 - 16. Platform Overload Indicator Light:** All movement is prevented when the light is illuminated. The platform load must be reduced before the machine will operate.

6. Controls

7. Daily Inspection and Maintenance

At the start of each work day (or 8 hour shift), the machine qualified operator must perform the Daily Inspection Maintenance (or Pre-Operation Inspection as it is sometimes referred to), as listed in the table below.

The purpose of the Daily Inspection and Maintenance is to keep the S3970RT / S3370RT / S2770RT in proper working condition and to detect signs of malfunction at the earliest possible time.

This chapter shows how to perform the inspection and maintenance required for each item in the daily inspection and maintenance table. The machine should be in the stowed position and the

Master Key Switch set to OFF before you begin this inspection.

Defective parts and/or equipment malfunctions jeopardize the safety of the operator and other personnel and can cause damage to the machine.

DANGER

The potential for an accident increases when operating a machine that is damaged or malfunctioning. Death or serious injury can result from such accidents. Do not operate a machine that is damaged or malfunctioning.

■ Daily Inspection and Maintenance Table

Item	Service Required
Rough terrain scissor interlock tests	Perform the tests to ensure the system is functioning
Fuel level	Visually inspect
Fuel filter (diesel engines only)	Visually inspect (condition)
Fuel leaks	Visually inspect (hoses and connections etc)
Engine oil	Check oil level (between dipstick lines)
Engine coolant	Check fluid level and radiator hoses
Radiator cap	Visually inspect installation)
Swinging gate	Visually inspect (installation, operation)
Wiring harnesses and connectors	Visually inspect (installation, operation)
Battery terminals	Visually inspect (no corrosion)
Battery fluid level	Visually inspect (covers plates)
Hydraulic tank cap	Visually inspect installation)
Hydraulic oil level	Check fluid level (at line on side of tank)
Hydraulic oil leaks	Visually inspect (hoses,tubes)
Tires and wheels	Visually inspect (condition)
Bolts,fasteners and pin keepers	Visually inspect (looseness)
Structural damage, corrosion and welds	Visually inspect (welds, cracks, dents, corrosion)
Guardrails	Visually inspect (condition)
Lanyard anchorages (option)	Visually inspect (condition)
Bubble level at base	Visually inspect (condition)
Guides, rollers and slides	Visually inspect (condition)
Non slip tread grip	Visually inspect (condition)
Wrist support	Visually inspect (condition)
Operator manual	Visually inspect (that the manual is in the holder)
Placards, decals, and Operators Manual	Visually inspect (installation and condition)
Air filter	Check condition
START THE ENGINE FROM THE GROUND CONTROL BOX	
Ground controls	Actuate and visually inspect for operation
Emergency lowering	Check operation (causes correct motion)
Platform controls	Actuate and visually inspect for operation
Flashing light	Visually check (operation)
RCD / ELCB (option)	Check operation
Safety prop	Check operation
Parking brakes	Check operation

7. Daily Inspection and Maintenance

■ Rough Terrain Scissor Interlock Tests

All Snorkel scissor lifts in the Snorkel 'SRT, SR and S/RT Series are fitted with a very important safety feature, a 'Stabiliser/axle/scissor Interlock' system that prevents the stabilisers being moved while the platform is elevated, and prevents the platform being raised if the rear axle is oscillated and the stabilisers are not set or the machine is tilted.

The correct operation of the Stabiliser/scissor Interlock is critical to ensure that the Scissor is operated safely and with minimum risk.

DANGER

To ensure the interlock system is functioning correctly before operating the scissor the following test must be carried out prior to operation each day, in conjunction with all other relevant daily pre-operational checks:

Stabiliser locked out when platform elevated test

1. Position the machine on a firm level surface.
2. From the platform controls, start the engine and allow it to warm up.
3. Raise the platform above the elevation switch, until the engine RPM drops to idle (approx 1.5 metres, depending on model).
4. Operate the right front stabiliser extend switch while watching the stabiliser leg for movement
5. If the stabiliser legs moves, release the switch **immediately!** Lower the platform fully, remove the machine from service and fix a Danger Tag warning others that the machine is not to be used. In the first instance contact the owner who will then contact the Snorkel branch or authorised agent to inspect, repair and test the machine before allowing it to be placed back into service.
6. Lower the platform to the stowed position

Elevation locked out when axles not stowed test

7. Park the machine such that one rear wheel is in a depression (approx 100mm deep) such that the axle switch opens. A kerb or gutter may be sufficient.

8. Raise the platform above the elevation point (approx 1.5 metres, depending on model).
9. At this point, an alarm will sound and further lift or drive will be disabled.
10. If there is no alarm and/or the machine continues to allow lift **stop immediately!** Lower the platform fully, remove the machine from service and affix a Danger Tag warning others that the machine is not to be used. In the first instance contact the Snorkel branch or authorised agent to inspect, repair and test the machine before allowing it to be placed back into service.

11. Repeat steps 7-10 for opposed rear wheel.

12. Lower the platform to the stowed position.

Elevation locked out when tilted test

13. Park the machine on ground known to exceed the tilt limit specified on the serial plate.
14. Raise the platform above the elevation point (approx 1.5 metres depending on model).
15. At this point, an alarm will sound and further lift or drive will be disabled.
16. If there is no alarm and/or the machine continues to allow lift **stop immediately!** Lower the platform fully, remove the machine from service and affix a Danger Tag warning others that the machine is not to be used. In the first instance contact the owner who will then contact the Snorkel branch or authorised agent to inspect, repair and test the machine before allowing it to be placed back into service.
17. Lower the platform to the stowed position.
18. If all steps have been followed and the Stabiliser / Scissor interlock is functioning correctly, the machine can now be used in accordance with the operating instructions provided in the Operators Manual.

■ Fuel Level



Figure 7.1 - Fuel Level

Remove the fuel tank cap. Visually check to see that the (optional gasoline) diesel tank is full. Replace the tank cap and tighten. Check to see that there is no water in the tank bottom.

□ Fuel Filter (diesel engines only)

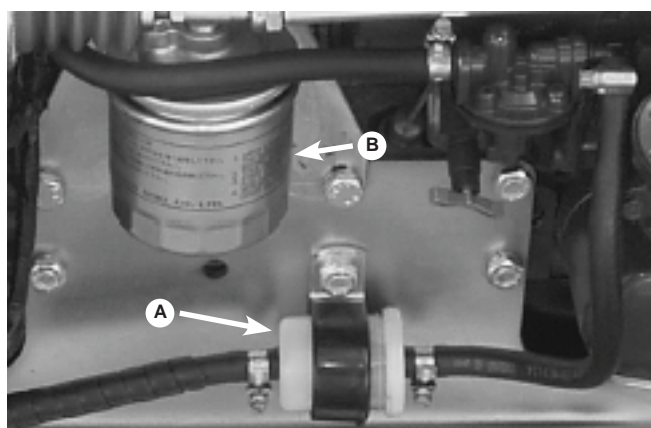

Figure 7.3 - Fuel Filter

The D902 has, in addition to the filter (B), a pre-filter unit (A). Visually check to see that the pre-filter is not full of contaminants.

■ Fuel Leaks

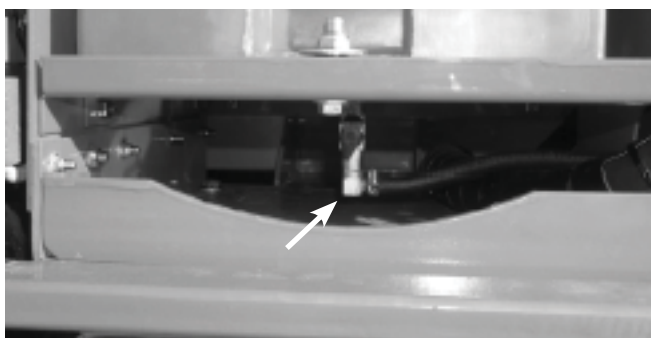

Figure 7.4 - Fuel Leaks at Tank

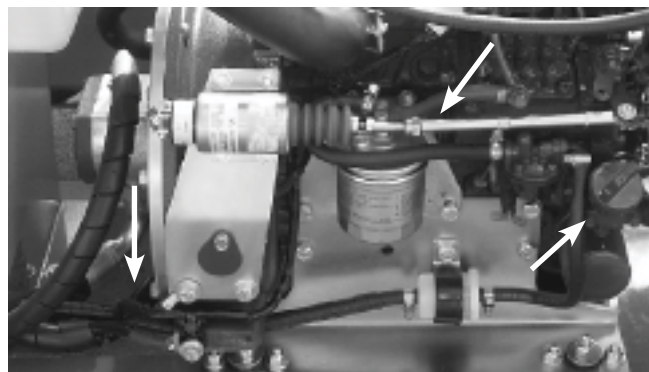

Figure 7.5 - Fuel Leaks in Hoses & Joints

Visually inspect the entire length of the fuel line, from the engine to the fuel tank, for leaks.

■ Engine Oil

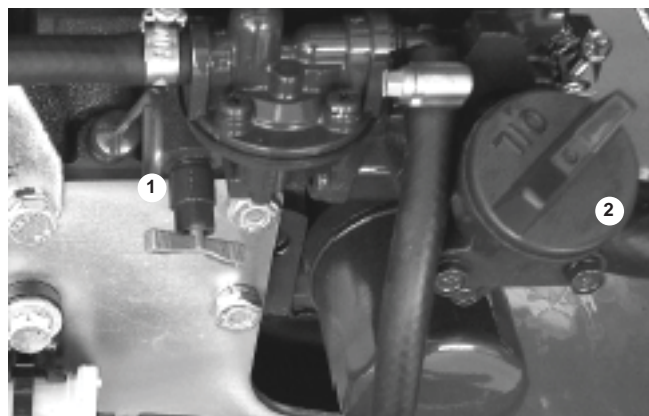

Figure 7.6 - Engine Oil Level

Keep the oil level between the marks on the dipstick (1) (see Figure 7.6).

The distance between the top and bottom dipstick marks corresponds to about 1 qt. (one (1) litre). Add oil, if needed at the cap (2) (see Figure 7.6), there is an alternative filler cap on top of the engine.

See the Specifications chapter for the correct engine oil grade and weight.

7. Daily Inspection and Maintenance

■ Engine Coolant

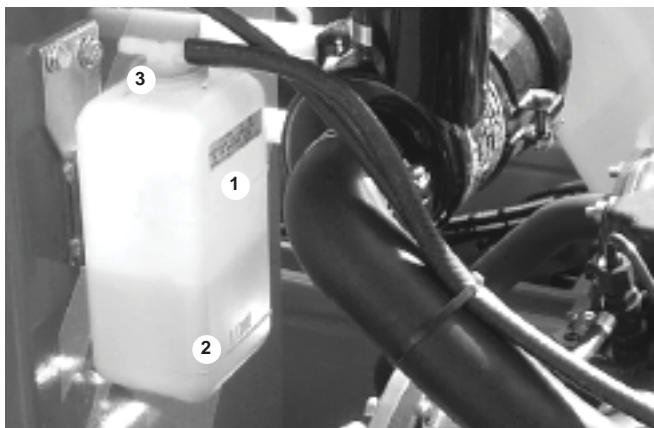

Figure 7.7 - Engine Coolant Level

The Kubota engine is liquid cooled. The coolant should be between the FULL level (1) and the LOW level (2) (see figure 7.7).

The coolant is half water and half ethylene glycol.

To add coolant:

Turn the engine OFF at the ground control box KEY SWITCH. Remove the cap (3) from the coolant reservoir. Add coolant and replace cap.

■ Radiator Cap

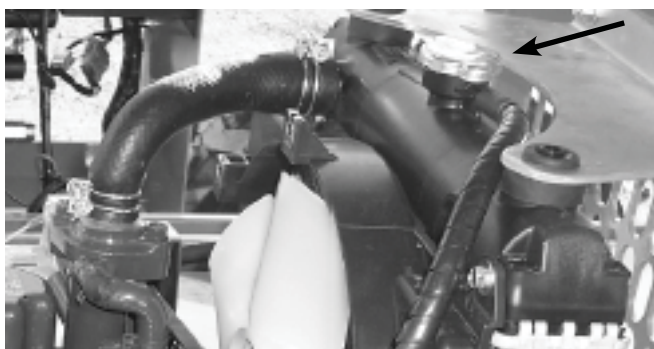

Figure 7.8 - Radiator Cap

Visually check to see that the cap is in place and tight.

■ Swinging Gate

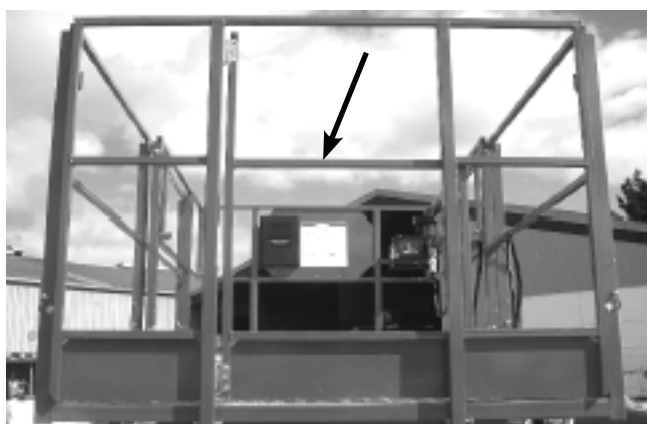

Figure 7.9 - Swinging Gate

Inspect the gate to see that it swings freely, latches securely, and is not deformed in any way.

■ Wiring Harnesses and Connectors

Inspect all the wiring harnesses on the machine for loose connections, broken wires and frayed insulation.

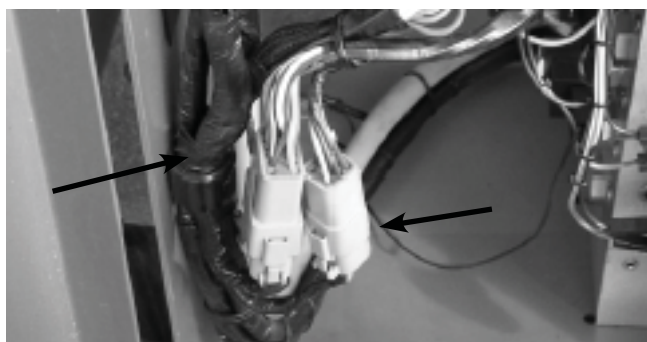

Figure 7.10 - Wiring Harnesses and Connectors

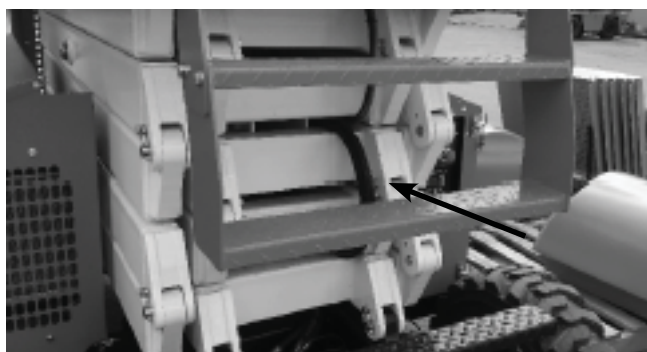

Figure 7.11 - Wiring Harnesses in the Scissor Stack

Pay particular attention to the wiring harnesses that are attached to the scissor stack. Note that the wire harness runs beside the main hose bundle.

7. Daily Inspection and Maintenance

■ Battery Terminals



Figure 7.12 - Battery Terminals

Battery Terminals should be clean and free of corrosion and the battery leads firmly attached.

□ Battery fluid level

▲ DANGER

Batteries emit hydrogen and oxygen, elements that can combine explosively. Death or serious injury can result from a chemical explosion.

DO NOT smoke or permit open flames or sparks when checking batteries.

Note

Units manufactured in New Zealand are typically fitted with a “maintenance free” battery.

If your unit is not fitted with such a battery you will need to do the following.

Remove the caps from the battery and visually check to see that the battery fluid is 1/4 (6mm) below the bottom of the filler neck inside each hole.

■ Hydraulic Oil Tank



Figure 7.13 - Hydraulic Oil tank

□ Hydraulic tank cap

Check to see that the cap (1) is in place and is tight (see figure 7.13).

□ Hydraulic oil level

To check the hydraulic oil level:

Completely lower the platform. The hydraulic oil level should be at the full level according to the gauge (2). If necessary add hydraulic oil at the hydraulic oil tank cap. See the specifications chapter for types and grades of hydraulic oil.

■ Hydraulic Oil Leaks

▲ DANGER

Leaking hydraulic oil can cause burns, fires, falls (slipping), cuts and puncture (if under high pressure). Do not tolerate hydraulic oil leaks, they are dangerous.

Do not search for the leaks with your hand, use a piece of cardboard or wood. Hydraulic oil leaks are easily visible and can show up anywhere. Visually inspect the entire machine for hydraulic oil. Check the ground underneath the machine for leaked oil.



Figure 7.14 - Check Fittings at Valve

Check all fittings and hoses for leaks. Inspect hoses for signs of damage from chaffing or rubbing against protrusions on the chassis or scissor stack.



Figure 7.15 - Check Hydraulic Cylinders

7. Daily Inspection and Maintenance

Pay particular attention to the cylinders, check to see that there is no oil leaking from the seal, also check all hoses that run to the cylinders.

Have a qualified trained maintenance person repair all hydraulic fluid leaks before you operate the machine.

■ Tires and Wheels

S3970RT / S3370RT / S2770RT tires are foam filled. Punctures of the type caused by bolts, screws or nails are not a problem.

Look for the large holes or long cuts completely through the tire body: holes or cuts where foam is being forced or eroded out of the tire.

Also look for large embedded objects, such as angle iron that can rip a tire body open under some conditions.

■ Bolts and Fasteners

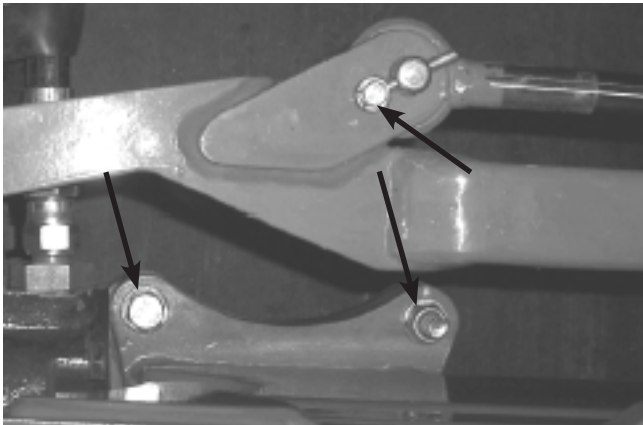

Figure 7.16 - Bolts and Fasteners

Visually inspect all fasteners to see that none are missing or obviously loose.

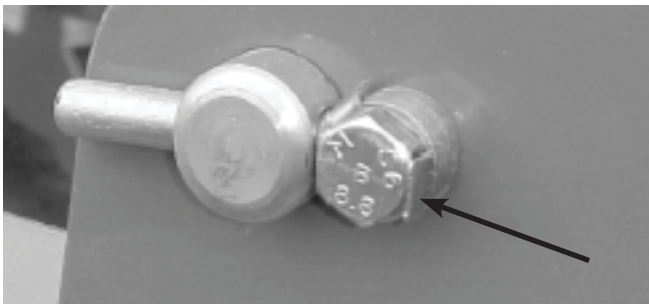

Figure 7.17 - Critical Pin Retainer Bolts

Critical pin retainer bolts have locktab washers fitted, they should all be present and not damaged in any way.



Figure 7.18 - Wheel Nuts

Pay particular attention to all of the wheel nuts. None should be visibly loose, missing or deformed.

A decal is attached to each wheel rim giving the correct torque settings for the wheel nuts, see small arrow.

▲ IMPORTANT

The correct torque setting for the S3970RT / S3370RT / S2770RT wheel nuts is 90 - 100 lb ft or 122 - 135 Nm. Do not tighten beyond these settings.

▲ CAUTION

Do not over tighten wheel nuts. Over tightened wheel nuts can damage or deform the wheel rim. This could lead to stability problems.

■ Structural Damage and Welds



Figure 7.19 - Structural Damage and Welds

7. Daily Inspection and Maintenance

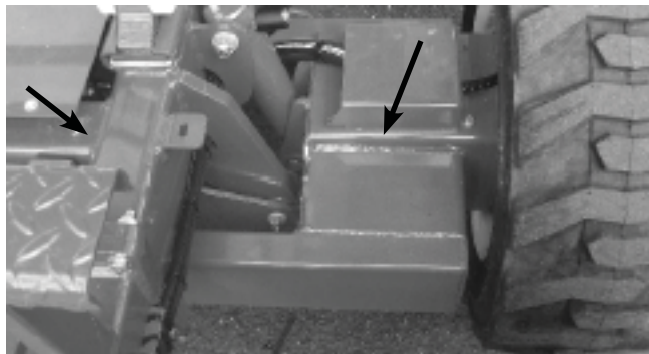

Figure 7.20 - Structural Damage and Welds

Visually inspect all welds for cracks, all structural members for deformity, and all sheet metal for dents that could interfere with machine operation.

■ Primary Fall Restraint System



Figure 7.21 - Primary Fall Restraint System

Ensure that all handrails are located correctly with each other and that all pins and bolts are in place.

If any part of the Fall Restraint System is not in place the System is compromised and the operator must review the Risk and Hazard Analysis and determine ways to provide adequate fall protection e.g. the use of Fall Restraint Harnesses, Lanyards and Anchors.

■ Bubble Level



Figure 7.22 Bubble Level

Visually check to see that the bubble level is not damaged, that it is full of fluid and the surface on which the bubble level is mounted to is not deformed or bent out of level.

■ Guides, Rollers and Slides

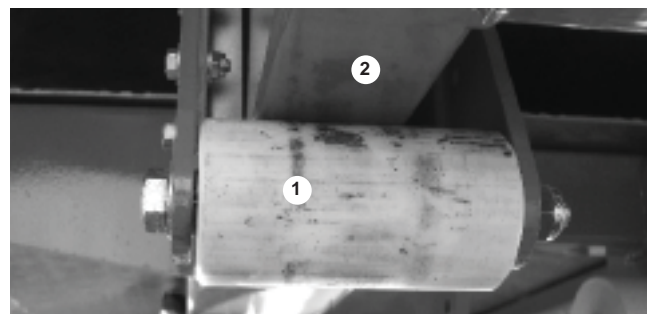
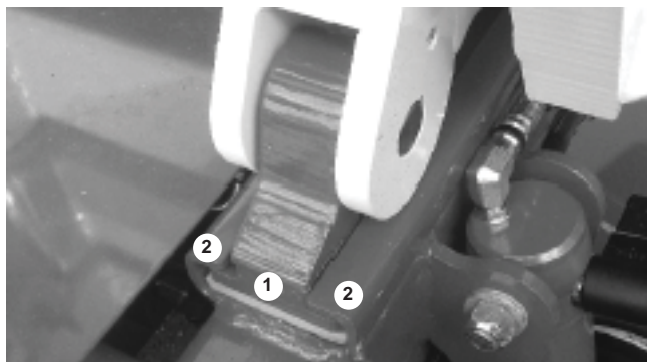

Figure 7.23 - Guides, Rollers and Slides

Visually check slides (1) and rollers (3) for wear or damage. Be sure that the guides (2) are free of debris and allow the slides and rollers to move smoothly.

Note

Start the engine and leave it running for the next step.

■ Ground Controls



Figure 7.26 - Ground Controls

7. Daily Inspection and Maintenance

Check the platform Lift / Lower switch (1) to see that it is functioning properly by holding the switch up to rise platform and pushing the switch down to lower the platform. Remember to hold the Enable switch (2) down while operating the Lift / Lower switch.

Pay particular attention to the Emergency Stop switch (3) to see that it turns the S3970RT / S3370RT / S2770RT engine off when struck.

■ Flashing Light



Figure 7.27 - Flashing light

Check to see that the light flashes approximately once a second when the S3970RT / S3370RT / S2770RT engine is running.

■ Platform Controls

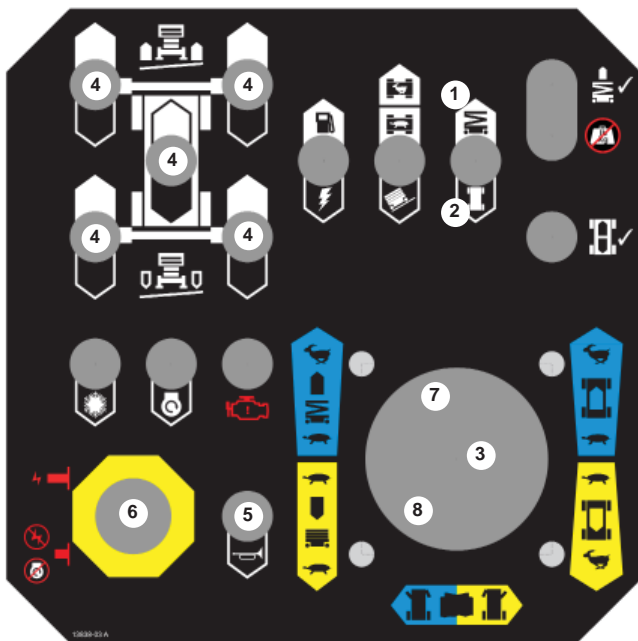

Figure 7.28 Platform Controls

Check all of the lift (1), drive (2), steer (3) and stabiliser (4) functions from the platform control box to see that they cause the S3970RT / S3370RT / S2770RT to move the way it should (see figure 7.28). For correct operating procedures see the Operations chapter.

Listen for the lowering alarm while the platform is going down. Listen for the motion alarm while the S3970RT / S3370RT / S2770RT is being driven forward. Listen for the back-up alarm while the machine is backing up.

Press the operator horn (5) to see that it works.

Pay particular attention to the Emergency Stop switch (6) to see that it turns the engine off when struck.

Pay particular attention to the Safety Control (7) to see that it deactivates the Joystick Controller (8) when the safety control (7) is released.

■ Emergency Lowering

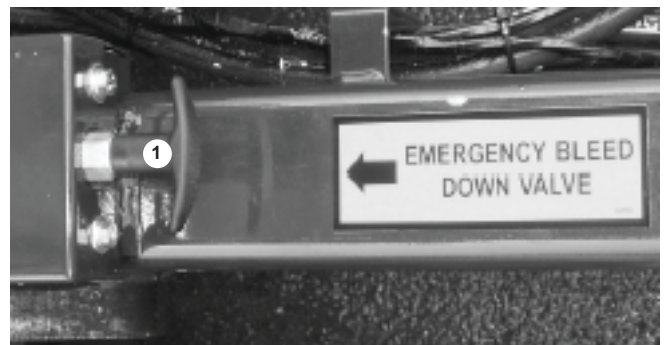

Figure 7.29 - Emergency Lowering

To check the emergency lowering: Raise the platform and turn the engine OFF at the ground control box KEY SWITCH.

Operate the emergency lower by pulling on the cable (1) (see figure 7.29) located at the front of the chassis. When the platform is fully lowered release the cable.

7. Daily Inspection and Maintenance

■ RCD / ELCB (Option)

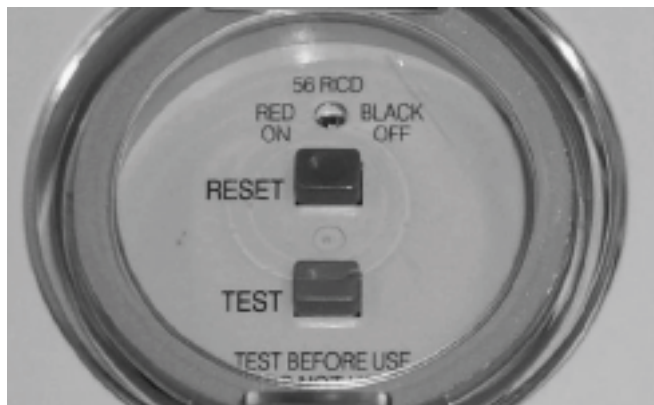

Figure 7.30 - RCD /ELCB

The RCD (Residual Current Device) is located at the ground and will protect against short circuits to earth. When there is a short circuit the RCD will shut down the 230V AC power to the platform outlet.

To reset the outlet disconnect the power tool lead from the platform box and reset the RCD at the ground.

If the problem persists call a trained service technician.

■ Safety Prop

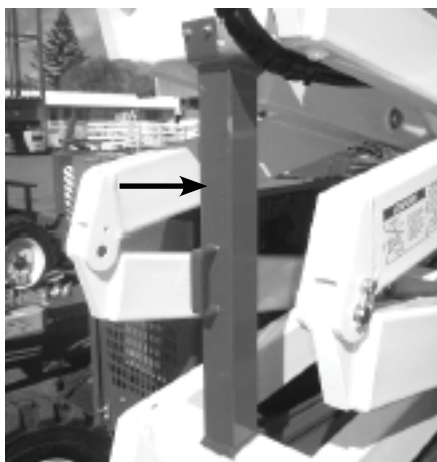

Figure 7.31 - Safety Prop

Inspect the safety prop(s) to see that it is present and moves freely.

■ Fall Restraint Lanyard Anchor Points (Option)

Check all three (3) of the Fall Restraint anchorages on the floor of the platform for the S3970RT / S3370RT / S2770RT to see that they are present, not deformed, that they move freely and that they are securely attached to the platform.

■ Non-Slip Tread Grip

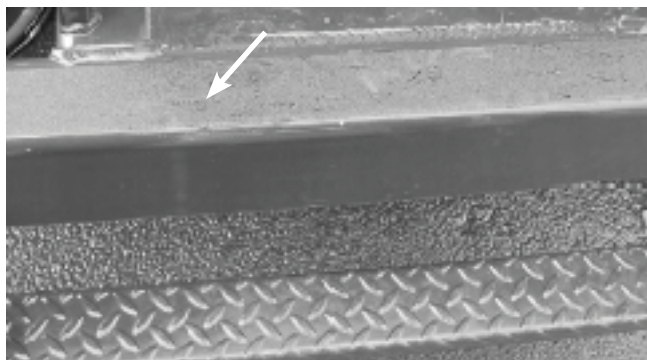

Figure 7.32 - Non Slip Grip Strip

Check that the non slip protective strip is in place and in good condition.

■ Wrist Support

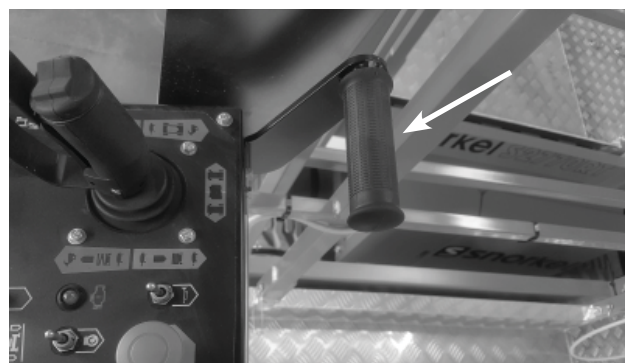

Figure 7.33 - Wrist Support

Check the condition of the rubber on the upper control box wrist support. Replace it if it is worn or damaged.

■ Operator Manual



Figure 7.34 - Operator Manual Holder

Check that the Operator Manual is in the holder.

7. Daily Inspection and Maintenance

■ Placards and Decals

Look to see that all placards and decals are in place and legible. Replace any missing or illegible placards or decals before placing the S3970RT / S3370RT / S2770RT into service for the daily work shift.

Item	Part No	Qty	Description
1	1843	1	Decal, Warning NZ Only
3	96924-9	4m	Decal, Warning Stripes Yellow/Black
4	12833-4	1	Decal, Serial Number 2770
	12833-4	1	Decal, Serial Number 3370
	12833-4	1	Decal, Serial Number 3970
5	511099-000	3	Decal, Snorkel
6	13903-14	2	Decal, S2770RT
	13903-15	2	Decal, S3370RT
	13903-10	2	Decal, S3970RT
7	11346-1	1	Decal, Rated Load S2770RT
	12699	1	Decal, Rated Load S3370RT
	12699-4	1	Decal, Rated Load S3970RT
8	0073298	1	Decal, Foam Tyres
9	451986	1	Decal, Interlocks
10	476706	2	Decal, Explosive Fumes (Outside cabinet door & fuel tank)
11	12574	1	Decal, Danger With Alarm
12	511101-000	2	Decal, Snorkel
13	13839-01	1	Decal, Lower Control Box Diesel
	13839-02	1	Decal, Lower Control Box ANSI Petrol/LPG
14	13838-03	1	Decal, Upper Control Box Diesel
	13838-04	1	Decal, Upper Control Box ANSI Petrol/LPG
15	0102006	1	Decal, Battery Disconnect
16	60572-6	1	Decal, Diesel Fuel (On fuel tank)
17	12753	1	Decal, Emergency Bleed Down
18	12814	1	Decal, Hydraulic Oil (On hydraulic oil tank)
19	583656	1	Decal, Safety Prop
20	96924-9	1	Decal, Warning Stripes Yellow/Black
21	300699	1	Decal, Operators Check List
22	0323897	1	Decal, Must Not Operate
23	621486	4	Decal, Forklift
24	302950	1	Decal, Hydraulic Oil Level
25	300700	1	Decal, Shearing Hazard
26	15170	1	Decal, Emergency Operation (Inside Of Door)
27	0083427	4	Decal, Lifting/Tie Down
28	56242-6	1	Decal, Operators Manual Enclosed
29	0372061	4	Decal, Torque Wheel Nuts
30	511067-000	2	Decal, www.snorkellifts.com
31	501453-000	4	Decal, Foot Crush Hazard
32	13640-3	1	Fall Restraint Only
33	0081441	1	Decal, Caution Liquid Withdrawl (Dual Fuel Only)

7. Daily Inspection and Maintenance

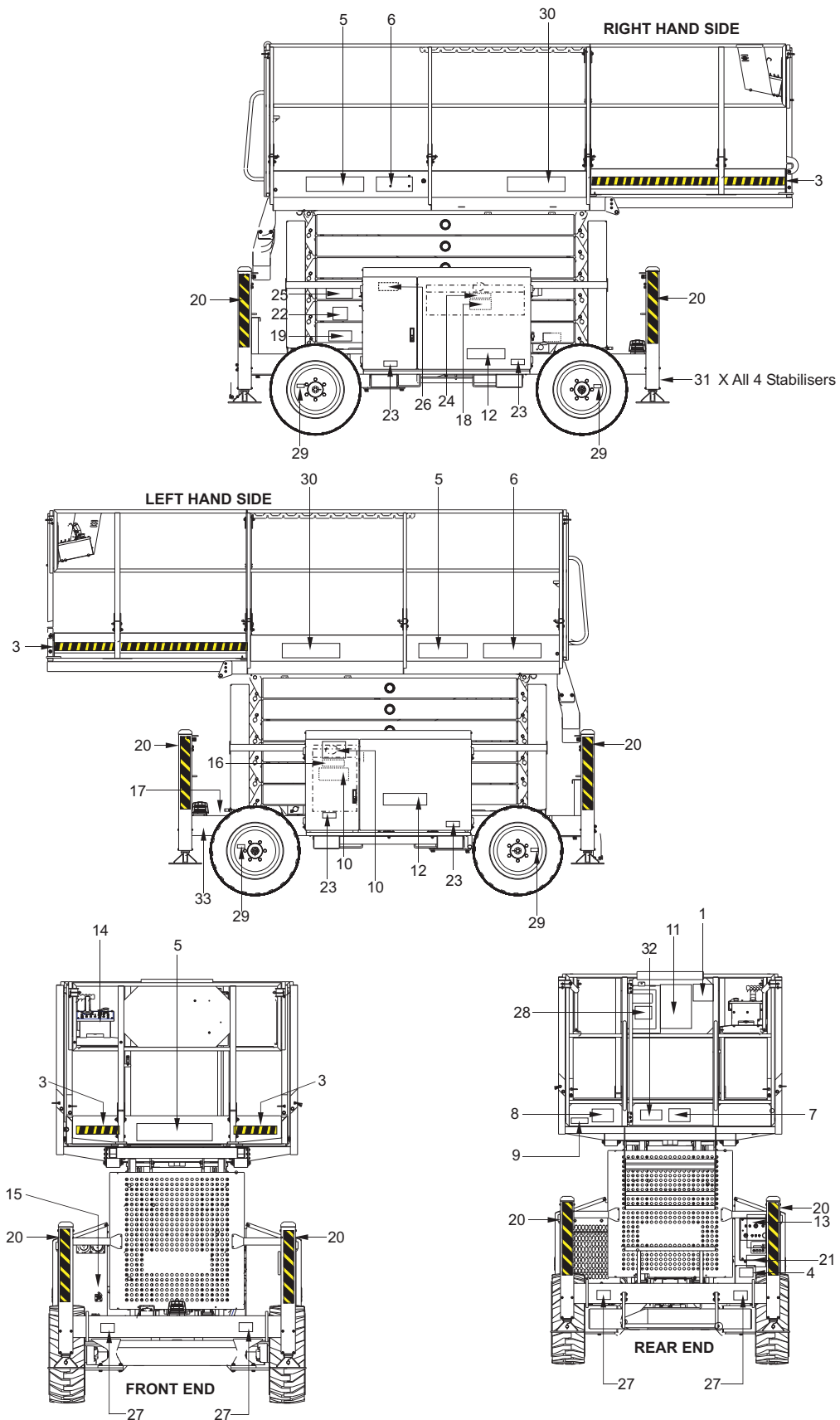

7. Daily Inspection and Maintenance

■ Operating Procedures

This chapter explains how to start and run the machine. Read and understand all the previous chapters before you begin to operate the machine.

■ Control Stations

The machine can be started and operated from the ground control box or the platform control box.

⚠ IMPORTANT

The ground control box can override the platform control box at any time. If a person operating the machine at any time becomes incapacitated, a person on the ground can always take over the machine control.

⚠ DANGER

The S3970RT / S3370RT / S2770RT is not electrically insulated

Death or serious injury to operating personnel can occur if the machine should come into contact with energised electrical wires during operation.

DO NOT attempt to operate the S3970RT / S3370RT / S2770RT ground controls if the platform, scissor assembly or any other conducting part of the machine is in contact with energised electrical wires or if there is an immediate danger of such contact.

Note

See the Electrical Hazard section, in this manual for a complete explanation of the hazards concerning electricity.

■ Emergency Stopping

⚠ WARNING

When the platform / ground key selector switch is set to **GROUND** the entire platform control box is inoperative including the Emergency Stop.

To stop the machine from the ground control box, push the Emergency Stop switch, at any time and the entire machine stops and nothing moves.

Push the emergency stop button inward when the upper or lower controls are not in use to protect against un-intentional operation.

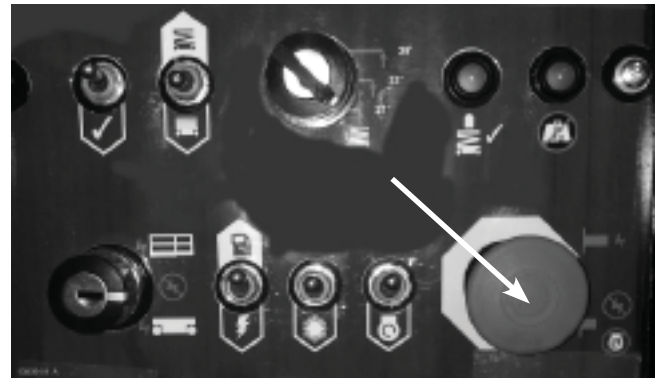

Figure 8.1 - Emergency Stop Switch at Ground Control Box

Ground control box Emergency Stop switch location.



Figure 8.2 - Emergency Stop switch at Platform Control Box

Platform control box Emergency Stop switch location.

To stop the machine from the platform control box, push the Emergency Stop switch, at any time and the entire machine stops and nothing moves.

Note

In order for the Emergency Stop switch to have an effect at the platform, the platform / ground key selector switch must be set on platform.

Note

For a complete discussion of the Emergency Stop switches, see Controls chapter, and Emergency Operation chapter 1, in this manual.

■ Operation Considerations

To use this chapter, first decide whether you will be starting and operating the S3970RT / S3370RT / S2770RT from the ground control box or the platform control box.

Begin at the section entitled Operating From The Ground Control Box if you intend to run the S3970RT / S3370RT / S2770RT from the ground control box.

8. Operation

Begin at the section entitled Operation From The Platform Control Box if you intend to start and run the S3970RT / S3370RT / S2770RT from the platform.

■ Operating From The Ground Control Box

To start the engine from the ground control box do the following:

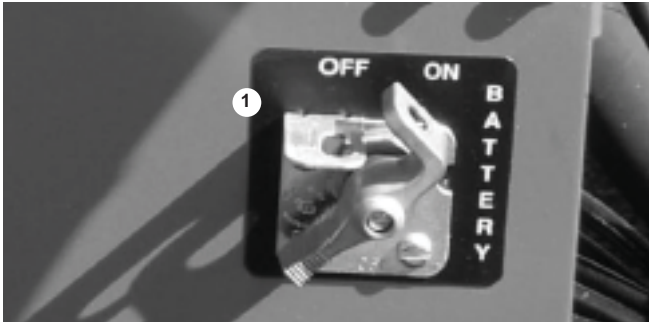

Figure 8.3

1. Set the battery switch (1) to on (see figure 8.3).



Figure 8.4

2. Set the Emergency Stop switch (2) to on (out) (see figure 8.4).
3. Set the ground / platform selector switch (3) to ground (see figure 8.4).
4. Press the glow plug switch (4) down and hold, for no longer than 20 seconds, then release it just before starting the engine for an engine that is at ambient air temperature (a cold engine) (see figure 8.4).
5. Press the start switch (5) down and hold it there until the engine starts or for 20 seconds, whichever comes first. When the engine starts, release the switch (5) (see figure 8.4).

⚠ CAUTION

If the engine does not start in 20 seconds, release the start switch (3) then wait 60 seconds before trying to start the engine again with the glow plug switch (4) and start switch (5).

■ Raising the Platform

To raise the platform from the ground control box, do the following:

1. The engine must be running. If not, start it from the ground control box as described above.

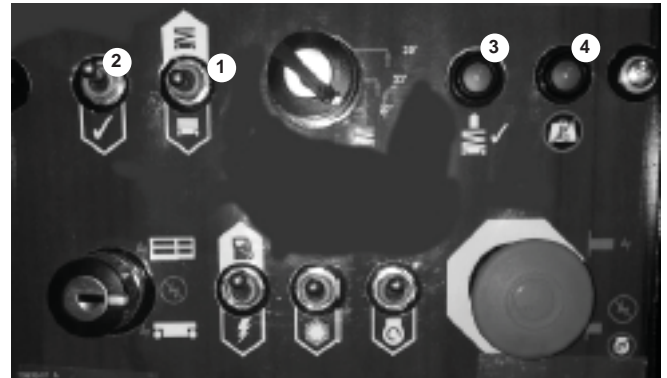

Figure 8.5

2. To raise the platform, press and hold the platform lift / lower switch (1) up whilst holding the enable switch (2) down (see figure 8.5).

Note

If the indicator light (3) is not lit, the platform will not rise because: the chassis is not level, the stabilisers (if present) are not properly set. Correct the problem then continue.

3. To lower the platform, press and hold the platform lift / lower switch (1) down whilst holding the enable switch (2) down (see figure 8.5).

■ Operating From The Platform Control Box

Before you begin to operate the S3970RT / S3370RT / S2770RT from the platform control box, a qualified operator must perform the Daily Inspection and Maintenance as described in chapter 7 of this manual.

To start the engine from the platform control box do the following:

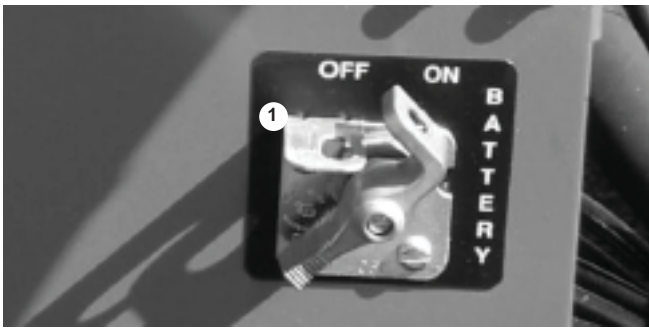

Figure 8.6

1. Set the battery switch (1) to on (see figure 8.6).



Figure 8.7

2. Set the Emergency Stop switch (2) to on (out) (see figure 8.7).
3. Set the ground / platform selector switch (3) to platform (up) (see figure 8.7)
4. Enter the platform and close the gate.

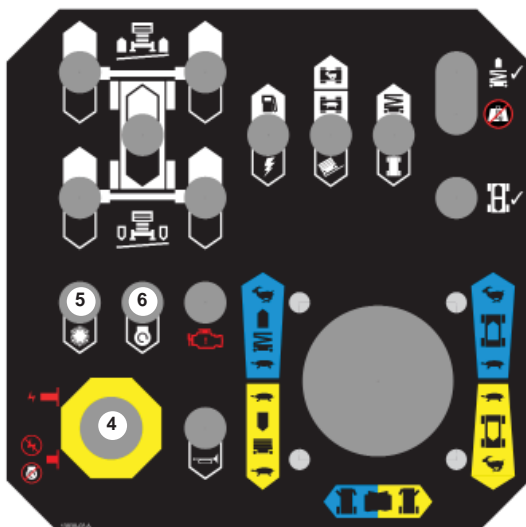

Figure 8.8

5. Pull the Emergency Stop switch (4) outward (on) (see figure 8.8).

6. Press the glow plug switch (5) down and hold, for no longer than 20 seconds, then release it just before starting the engine for an engine that is at ambient air temperature (a cold engine) (see figure 8.8).

7. Press and hold the start switch (6) down until the engine starts or for 20 seconds, whichever comes first. When the engine starts release the start switch (6) (see figure 8.8).

⚠ CAUTION

If the engine does not start in 20 seconds, release the start switch (6) then wait 60 seconds before trying to start the engine again with glow plug (5) and start switches (6).

8. Operation

■ Driving

1. The engine should be running. If not, start it from the platform control box as described previously.

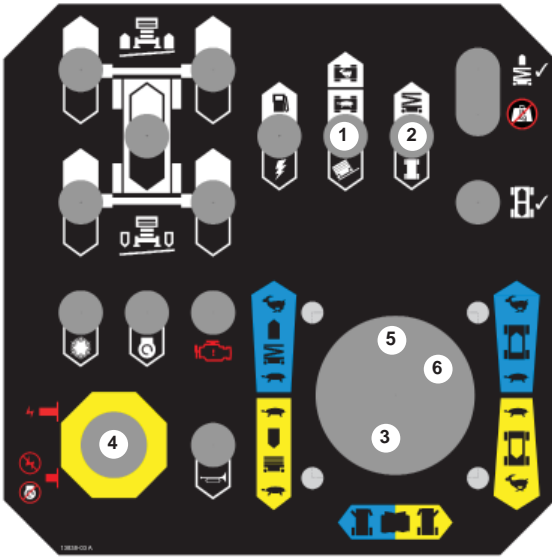

Figure 8.9

2. Set the speed switch (1) to turtle (slow) (see figure 8.9) if you are going to be driving close to other objects or need to move the S3970RT / S3370RT / S2770RT very slowly for other reasons.

Note

Setting the speed to rabbit doubles the travel speed. (See the specifications chapter for speeds or different models).

3. Set the lift / drive switch (2) to drive (see figure 8.9).

⚠ WARNING

The S3970RT / S3370RT / S2770RT is about to move. If you have to make an emergency stop, release the joystick controller (3) and sharply strike the Emergency Stop switch (4) straight in.

To make a normal stop, slowly move the joystick controller (3) (see figure 8.9).

4. Squeeze and hold the safety control (5) against the joystick controller (3) (see figure 8.9).
5. Push the joystick controller (3) slowly forward or pull it slowly backward, depending on which way you want to go. The further you move the joystick the faster the machine goes.
6. To make a right or left turn, press and hold the steering rocker switch (6) on top of the joystick controller (3) (see figure 8.9).

Note

When you release the steering rocker switch (6) the steering wheels remain pointed in the direction you left them. They do not return to straight ahead the way automobile wheels do. You will have to press the opposite side of the steering rocker switch (6) to return to straight line travel. In tight spots you should stop the S3970RT / S3370RT / S2770RT, turn the wheels the direction you want to go, then, after you have aimed the steering wheels, squeeze the safety controller (5) and move the joystick controller (3) slowly forward or backward.

□ Variable maximum drive speed

The machine features a variable maximum drive speed with height. As the elevation gets higher the drive speed reduces.

Stowed, and up to the elevation height, the maximum drive speed is the stowed drive speed. Above the elevation height maximum drive speed reduces as the height increases. At maximum elevation the maximum drive speed is the creep speed. At heights above elevation but less than full height this gives a significant increase in the maximum drive speed and corresponding increases in productivity (see example table below).

S3970RT	
Height	Speed
Stowed	4.5
10%	2.2
30%	1.55
50%	0.9
75%	0.63
100%	0.35

□ Ramp off

The controls feature a small amount of “ramp off”. If the trigger safety control is released or the joystick controller is abruptly moved to the center the drive speed will be reduced over a small period of time. This makes deceleration much smoother. There is a small amount of overrun of the machine. Take care to allow sufficient stopping distance from objects.

□ Raising the platform

To raise the platform from the platform control box do the following:

1. The engine must be running. If not, start it from the platform control box as shown above.

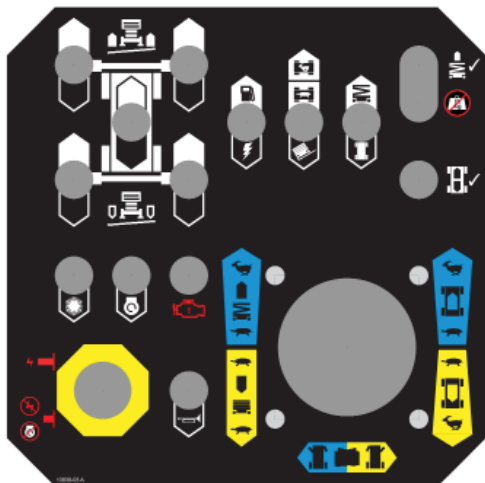

Figure 8.10

2. Set the drive / lift selector (1) (see figure 8.10) to lift.

Note

If the lift indicator light (2) is not lit, the platform will not go up because: the chassis is not level, the stabilisers are not properly set or the articulating axles are not set.

Note

The platform is about to move. If you have to make an emergency stop, release the joystick controller (3) and sharply strike the emergency stop switch (4) straight in.

To make a normal stop, slowly move the joystick controller (3) to its centered neutral position then release it.

3. Squeeze and hold the safety control (5) against the joystick controller (3) (see figure 8.10).
4. Push the joystick controller (3) forward to raise the platform, or pull it backward to lower it. The further you push the joystick controller (3) forward the faster the platform rises. There is only one (1) lowering speed.

■ Stabilisers

If your machine is not fitted with stabilisers you do not need to read this section.

Note

Using the stabilisers.

The platform must be fully lowered to enable the stabilisers to operate.

Once the platform is raised the stabilisers cannot be set or adjusted.

Before operating the stabilisers check to see that the ground conditions under the four (4) stabiliser pads is firm, stable and unobstructed.

⚠ DANGER

If the platform is up and the ground compresses unevenly under different stabiliser pads the S3970RT / S3370RT / S2770RT might fall over causing serious injury or death. Check the level bubbles frequently during operation. If any movement of the bubble(s) occurs, immediately lower the platform and readjust the stabilisers to re-center the bubble(s) in the markers.

When using the stabilisers always check that all four (4) are firmly on the ground and that they are clear of manhole covers, drains, etc, which may collapse. If the ground is at all soft, suitable dunnage should be placed under the feet to spread the weight. If you are at all unsure regarding the load bearing situation consult a competent person.

⚠ DANGER

Death or serious injury can result if the machine tips over. Do not use the stabilisers to gain extra working height, they are not designed for that purpose. At least one (1) of the stabilisers should raise the S3970RT / S3370RT / S2770RT above the ground - use the other three (3) to level the S3970RT / S3370RT / S2770RT as necessary.

The S3970RT / S3370RT / S2770RT will not drive unless all four (4) stabilisers are completely raised i.e. If any one (1) of the stabilisers is even slightly lowered the drive function is disabled.

8. Operation

■ Operating The Stabilisers Manually

□ To set the stabilisers

1. The engine must be running and the S3970RT / S3370RT / S2770RT set for platform control box operation.

Note

In order to operate any of the stabilisers you must squeeze the joystick trigger (T) at the same time as you operate the individual stabiliser switches (1).

You must do this when raising or lowering the stabilisers.

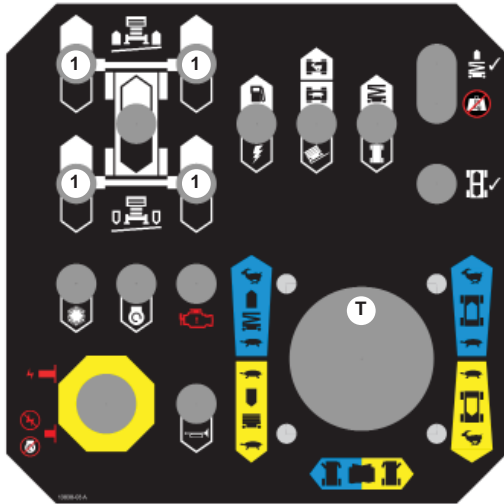

Figure 8.11

2. Pull and hold the stabiliser switches (1) backward one at a time, until all four stabiliser pads (2) contact the ground (see figure 8.12).

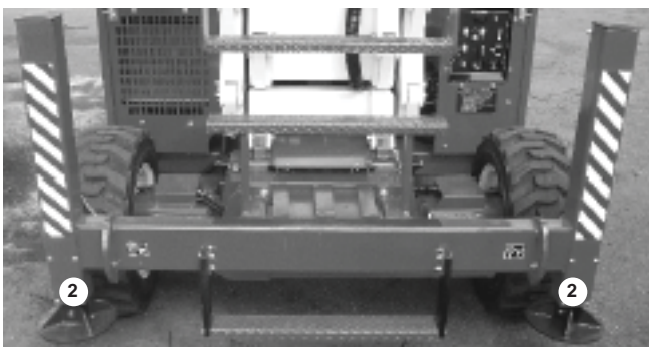

Figure 8.12

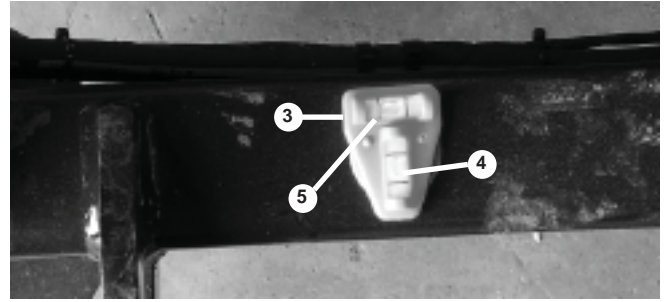

Figure 8.13

3. Visually check the level bubble (3) to determine which stabilisers must be further extended to level the platform (see figure 8.13).

Note

When the bubbles (4) and (5) are in the center of the marks the platform is level.

4. Lower the appropriate stabilisers just enough to center the bubbles (4) and (5) (see figure 8.13). When the lift indicator light (6) (see figure 8.14) comes on, the platform can be safely raised.

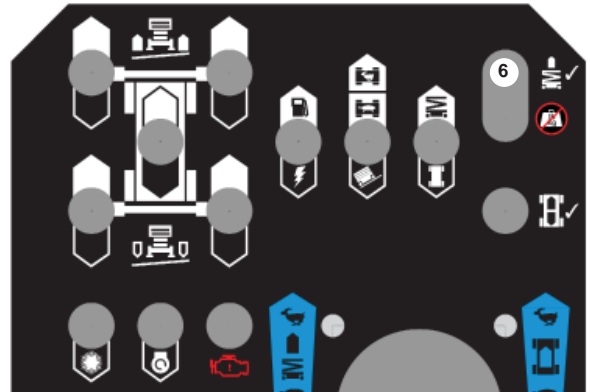

Figure 8.14

□ To raise the stabilisers:

Completely lower the platform. Then push and hold the stabiliser switches (7) forward until all the stabilisers are completely up (see figure 8.15).

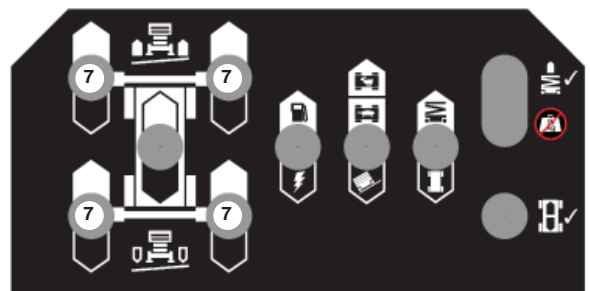

Figure 8.15

■ Operating the Auto Level System

□ Setting the stabilisers automatically

1. The engine must be running and the S3970RT / S3370RT / S2770RT set for platform control box operation.

Note

In order to operate the Auto Level stabiliser switch (1) you must squeeze the joystick trigger (T) at the same time as you operate the Auto Level switch.

You must do this when raising or lowering the stabilisers.

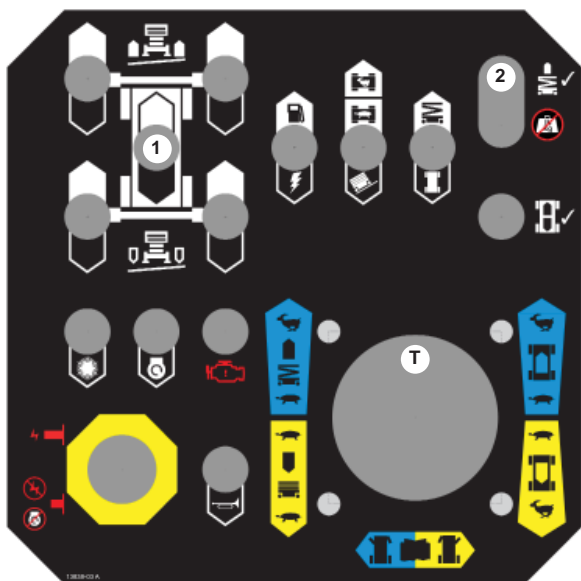

Figure 8.16

2. Press and hold the switch (1) down to the Auto Level position until all movement stops of the lift enable light (2) illuminates. The S3970RT / S3370RT / S2770RT will attempt to automatically level itself.
3. The lift enable light (2) will illuminate if all 4 feet are in contact with the ground and the machine is level.
4. If a stabiliser foot will not go down sufficiently to make contact with the ground it is possible that the cylinder has reached the end of its stroke. Retract all stabilisers and put suitable dunnage under the feet that did not touch the ground and repeat step 2.

Note

Manual or auto leveling is possible any time that stabiliser movement is allowed. For example, the machine can be manually leveled part way and then auto leveled without the necessity of retracting the stabilisers between the two (2) operations.

□ Raising the stabilisers automatically

1. Completely lower the platform.
2. Press and hold the switch (1) up to the Auto Stow position. The stabilisers will raise to the stowed position.

■ The Risks of Operating Scissor Lifts on Outriggers on Ramps and Slopes

There is a risk of scissor lifts with outriggers sliding down ramps, driveways, underground car park entry ramps and outdoor slopes. The contributing factors include newly painted ramps, icy, wet oil and sand covered ramps, grassy and loose surface slopes.

This can occur when the platform is fully lowered or when elevated.

Do not attempt to pack wheel chocks or timber under the outrigger footplates or the tyres.

The outrigger foot plates must be lowered only onto a firm surface that can support the load of the S3970RT / S3370RT / S2770RT and its rated capacity.

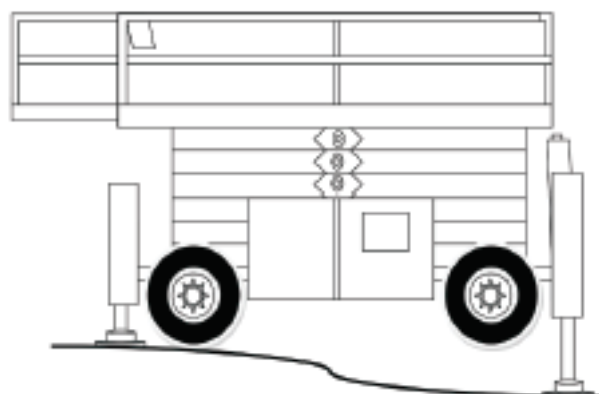

Figure 8.17

The positioning of outrigger footplates on stepped level surfaces (capable of supporting the S3970RT / S3370RT / S2770RT) is acceptable (see figure 8.17 & 8.18)

8. Operation

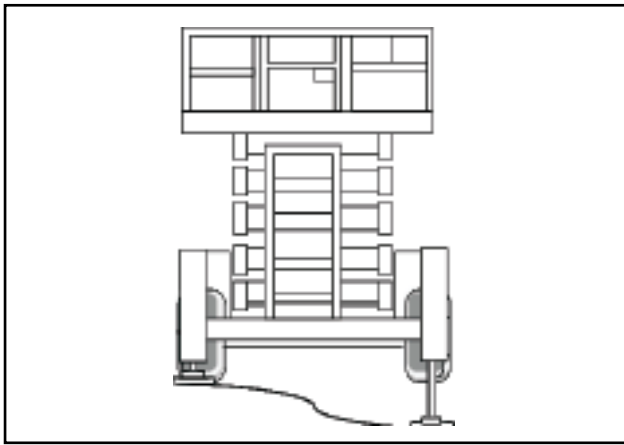

Figure 8.18

The positioning of outrigger footplates on ramps and slopes creates the risk of the machine sliding down the ramp or slope (see figure 8.19 & 8.20).

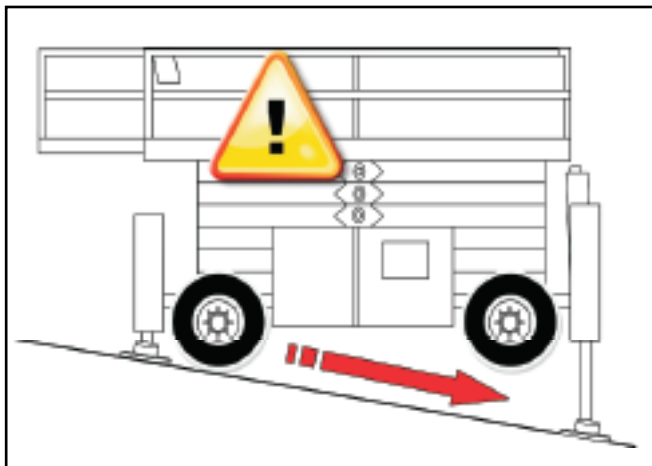

Figure 8.19



Figure 8.20

A competent person shall assess slope and surface conditions before setting up the machine on a slope.

■ Extending The Multi-Position Platform

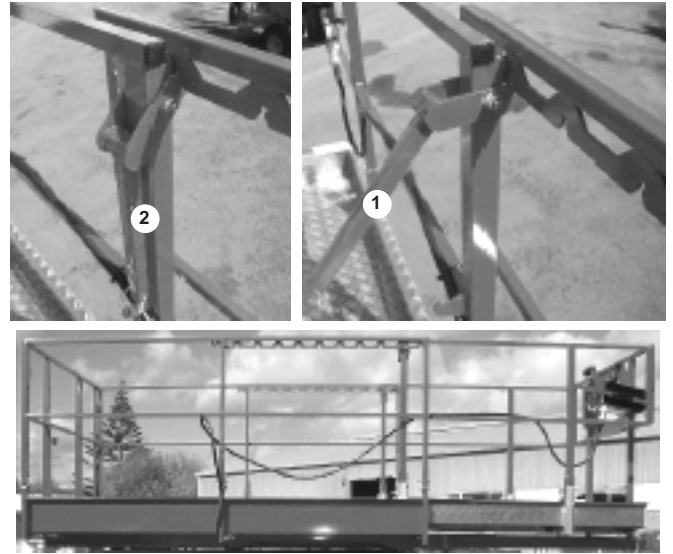

Figure 8.21.

The multi-position extendable platform (see figure 8.21) can be securely locked into different positions. To move it from one position to the other, do the following:

1. Stand on the non-extendable part of the platform and face the front of the machine.

⚠ WARNING

The distribution of the rated work load changes when the extendable platform is extended. Read the decal on the toe board at the front of the platform or at the entrance to the platform for safe weight distribution.

2. Lift up the deck extension handles (one for each side of the deck) (1) to unlock the deck (see figure 8.21).
3. Push or pull the deck extension handles to move the platform to the desired position.
4. Lower the deck extension handles and allow the lock (2) to locate (see figure 8.21).

■ Emergency Operation Procedures

The following procedures are emergency procedures only. Do not use them for normal operation. Their purpose is to get the platform and operator safely to the ground when the S3970RT / S3370RT / S2770RT will not start or some other problem keeps the platform from lowering in the normal way, or to move the S3970RT / S3370RT / S2770RT a short distance to a safe place when the motor will not start.

There are three (3) forms of emergency operation for the S3970RT / S3370RT / S2770RT. Emergency stop, emergency bleed down and pushing.

Each is covered in a separate section below:

■ Emergency Stop

There are two (2) Emergency Stop switches on the machine.

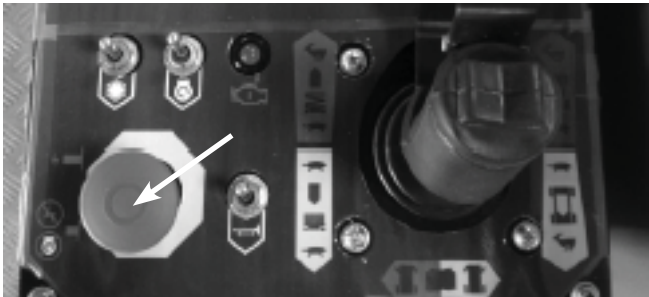

Figure 9.1 - Platform Control Box Emergency Stop Switch



Figure 9.2 - Ground Control Box Emergency Stop Switch

WARNING

When the platform / ground key selector switch is set to ground the entire platform control box is inoperative including the emergency stop.

Push either emergency stop switch (see figures 9.1 & 9.2) at any time, and the entire machine stops, the engine turns off and nothing moves.

Note

In order for the emergency stop switch to have an effect at the platform, the platform / ground selector switch must be set on platform.

Functionally, the emergency stop switches do the same thing as turning the main power switch to off. The emergency stop switches are designed to be easier to find and faster to use than key switches.

To reset the emergency stop at the platform control box or the ground control box, pull it and it will pop out (on). The S3970RT / S3370RT / S2770RT engine can then be restarted in the normal way.

■ Emergency Bleed Down

The S3970RT / S3370RT / S2770RT platform can be lowered from the platform control box anytime there is electricity to the platform control box the S3970RT / S3370RT / S2770RT engine does not have to be running.

If you are working from the platform and the engine dies and cannot be restarted, do the following:

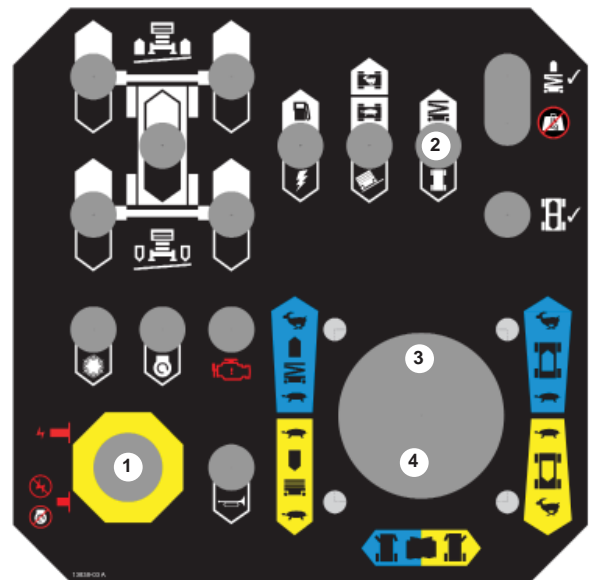

Figure 9.3

1. Check to be sure the emergency stop switch (1) is pulled out (on) (see figures 9.1 and 9.3).
2. Set the selector switch (2) (see figure 9.3) to the platform function (up).

9. Emergency Operation

- Squeeze the safety control (3) and pull the joystick controller (4) (see figure 9.3) backward. The platform should lower. If it does not lower, call for help from someone on the ground.

The person on the ground should do the following:

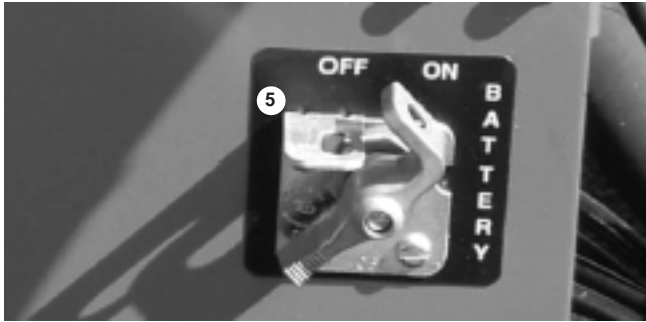

Figure 9.4

- Check to be sure the battery switch (5) is on (see figure 9.4).



Figure 9.5

- Check to be sure the emergency stop switch (6) (see figure 9.5) is on (out).
- Check to be sure the selector switch (7) is set to platform (up) (see figure 9.5).
- If the battery switch (5), emergency stop (6) and selector switch (7) are all set correctly, and the engine will not start from the platform control box, set the selector switch (7) to ground (down) and try to lower the platform from the ground control box.

DANGER

Pinching and crushing hazard. At the next step the platform will come down and the scissor arms will close. Keep all body parts out of the scissor arms and out from under the platform.

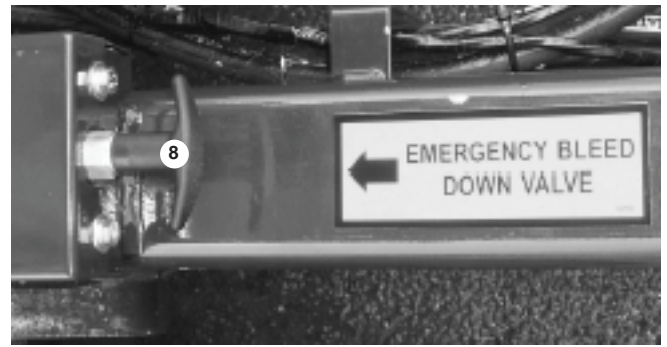

Figure 9.6 - Manual Bleed Down Control

- If the platform will not lower, the person on the ground will need to use the manual bleed down (8) (see figure 9.6) located at the front of the chassis. To lower the platform pull on the cable (8) until the platform is fully lowered.

Note

If the platform does not come down, refer the problem to a qualified trained service technician.

■ Pushing / Towing

When stowed the machine can be safely pushed or towed to level firm surfaces. To do so:

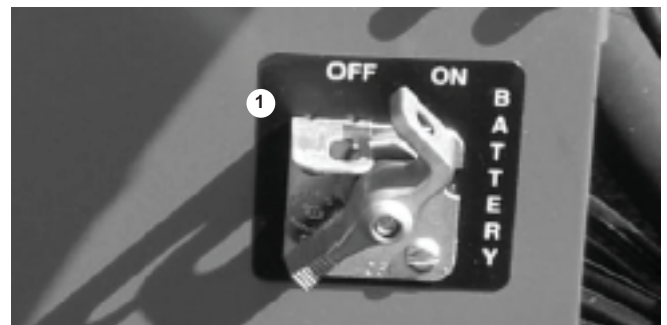

Figure 9.7

- Turn the battery switch (1) to off (see figure 9.7).



Figure 9.8

- At the ground control box set the emergency stop switch (2) to off, turn the main power switch (3) off and remove the key (see figure 9.8).

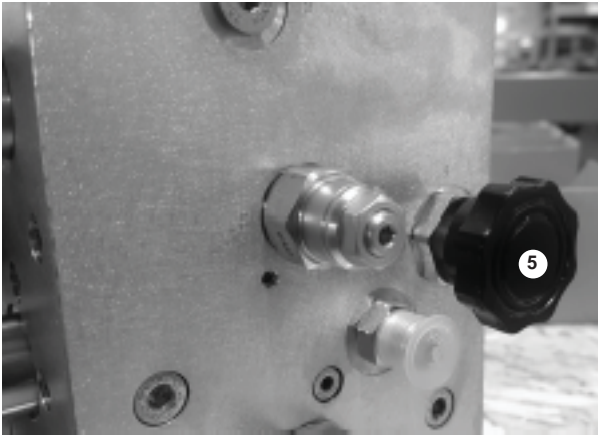

Figure 9.9

- Inside the hydraulic compartment, open the free-wheeling valve (5) by turning it counterclockwise until the knob stops (see figure 9.9).

⚠ DANGER

A runaway S3970RT / S3370RT / S2770RT can cause death or serious injury. At the next step the S3970RT / S3370RT / S2770RT brakes will be released. Do not proceed to the next step unless the machine is on a level surface or the machine is securely attached to another vehicle that has the capacity to safely control the machine on a grade.

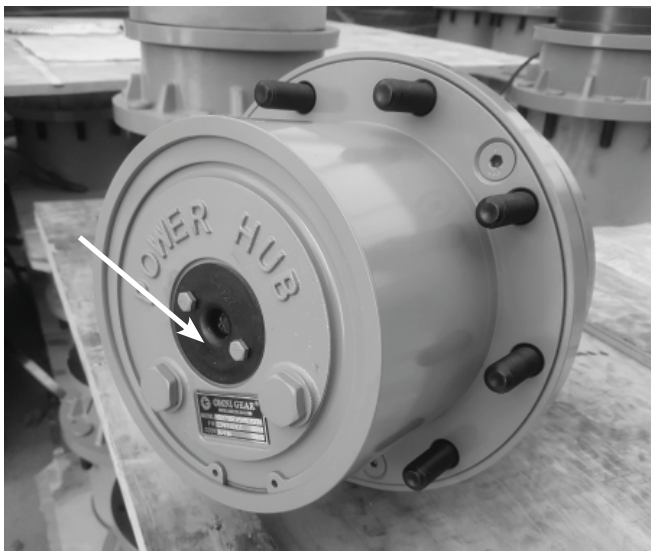

Figure 9.10

- At the rear drive wheels, remove the two bolts from the disconnect plate. Turn the plate over so the nipple points inward. Reinstall the two bolts (see Figure 9.10).

⚠ CAUTION

The S3970RT / S3370RT / S2770RT drive motors will be ruined if the machine is pushed (or pulled) faster than 2 mph (3.2 km/h). Unless personnel safety considerations dictate otherwise, do not push (or pull) faster than 2 mph (3.2 km/h).

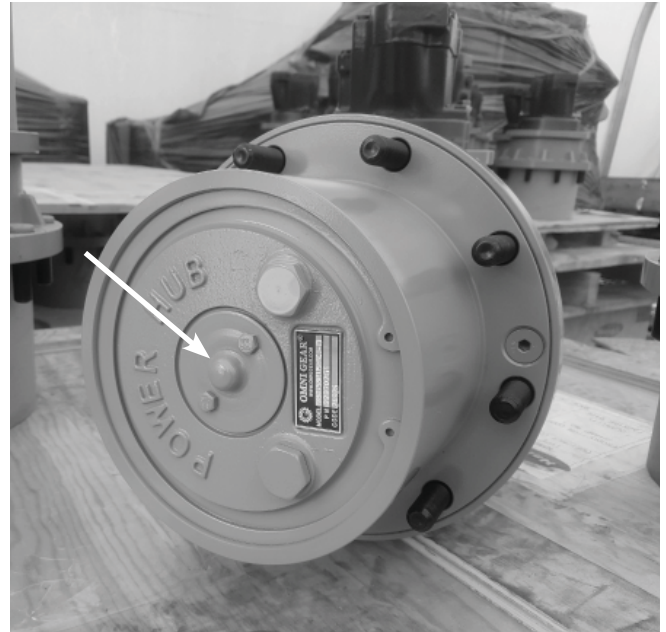

Figure 9.11

- Once the unit has been safely pushed / towed close the freewheel valve by turning it clockwise. At the rear drive wheels, remove the two bolts from the disconnect plate, turn the plate so the nipple points outward and reinstall the two bolts (see Figure 9.11).

The unit is now ready for normal operation.

9. Emergency Operation

10. Stowing and Transporting

■ Stowing

At the end of each work day (or in preparation for transporting, pushing, lifting or storage) a qualified operator should put the S3970RT / S3370RT / S2770RT into its stowed position then lock it.

The correct stowed position is shown here.



Figure 10.1 - Correct Stowed Position

To bring the S3970RT / S3370RT / S2770RT into the stowed position use the controls on either the ground control box or the platform control box.

1. Fully lower the platform.
2. Use the stabiliser controls to completely raise all four (4) of the stabilisers.
3. Close the platform entry gate and close all the doors on the machine.

□ To lock the machine:



Figure 10.2

1. Push the emergency stop switch (1) in (off) and set the main power switch (2) to off then remove the key (see figure 10.2).

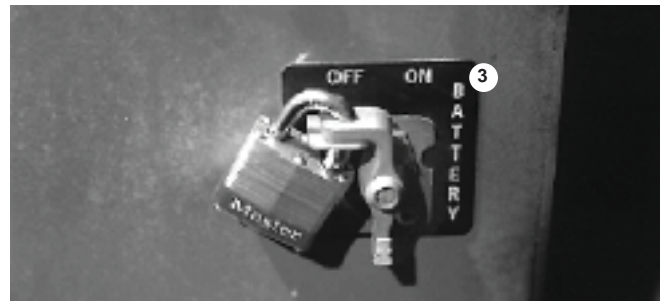

Figure 10.3

2. Turn the battery switch (3) off and padlock it (see figure 10.3).

■ Transporting

□ Trailering

⚠ WARNING

Only suitably trained personal are permitted to load the S3970RT / S3370RT / S2770RT onto trucks.

⚠ DANGER

S3970RT / S3370RT / S2770RT's weigh up to 3620kg (7964 lb) depending on the model. Loading ramps must be able to support that weight. Transport trailers must be able to safely transport that weight.

S3970RT / S3370RT / S2770RT brake and drive systems are not designed for grades over 35%. Drive slowly and carefully on all slopes and loading ramps.

10. Stowing and Transporting

To safely drive a machine onto a transport trailer:

1. Visually inspect the alignment of the loading ramp and the truck or trailer. They should both be on the same straight line.
2. Set the S3970RT / S3370RT / S2770RT ground control box for platform operation.
3. Enter the platform and close the safety gate.
4. Use the platform controls to bring the machine into the stowed position at the foot of the loading ramp with the steering wheels nearest the ramps.
5. Visually check (from the platform) to be sure the S3970RT / S3370RT / S2770RT is aligned with the ramp and the ramp is still aligned with the truck or trailer. All should be in a straight line.

⚠ DANGER

Death or serious injury can result from losing control of the machine during loading or unloading. Always drive up or down a grade with the speed switch set to turtle (slow).

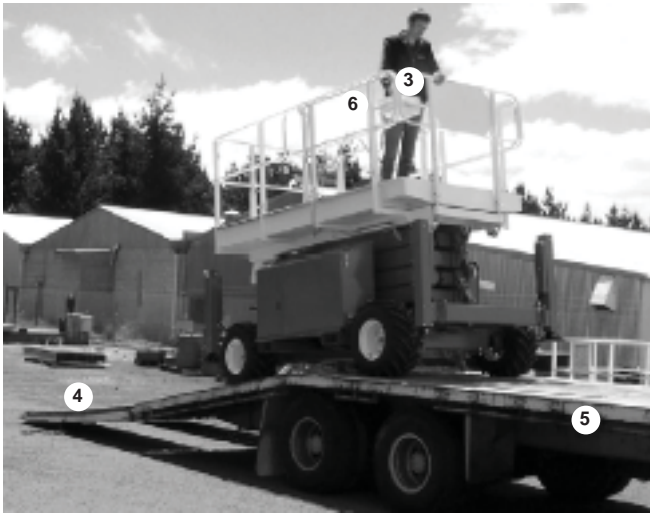

Figure 10.4

6. Use the joystick controller (3) to slowly drive the S3970RT / S3370RT / S2770RT straight onto the ramp (4) and trailer (5) (see figure 10.4).
7. When the S3970RT / S3370RT / S2770RT is in place on the trailer, push the emergency stop switch (6) in (off) at the platform control box.
8. Chock the S3970RT / S3370RT / S2770RT wheels.

□ Securing to a transport vehicle

This procedure assumes that you have just finished the previous section and that the wheels are chocked.



Figure 10.5

1. Push the emergency stop switch (1) in (off) and set the main power switch (2) to off then remove the key (see figure 10.5).

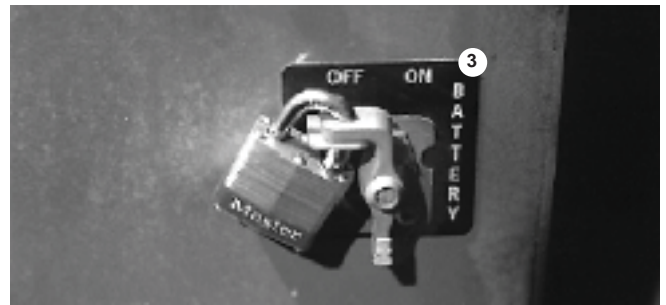

Figure 10.6

2. Set the battery switch (3) (see figure 10.6) to off and padlock it.

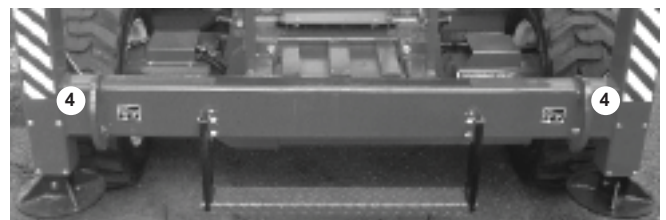

Figure 10.8 - Tie-down Lugs

Always attach chains to the front and back tie-down lugs (4) (see figures 10.8 & 10.9).

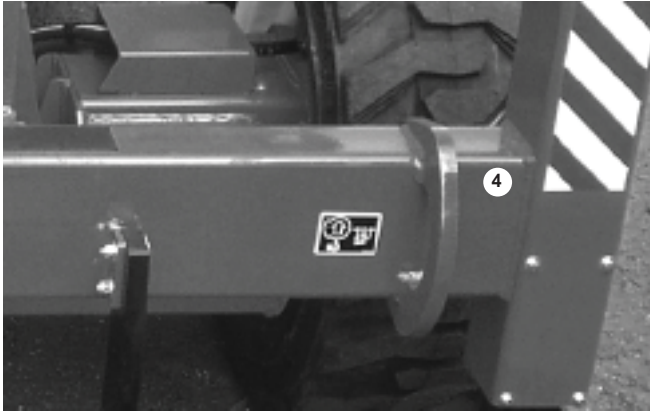

Figure 10.9 - Tie-down Lugs

Chocks may be removed at this time, though it is a good idea to leave them in place.

Reverse the above procedure after transporting.

Towing

Do not tow the machine. The S3970RT / S3370RT / S2770RT hydraulic drive motors will be permanently damaged, and rendered useless, by towing speeds.

Lifting

▲ WARNING

Lifting the S3970RT / S3370RT / S2770RT must only be performed by a competent person.

The competent person must refer to the machine specifications in the manual and on the serial plate.

The machine must only be lifted by the lifting lugs. Lifting the machine requires the use of suitable rated and approved lifting equipment.

The competent person shall plan the lift including selecting the appropriate equipment. It is suggested that spreader bars or similar be used to avoid damage to the S3970RT / S3370RT / S2770RT.

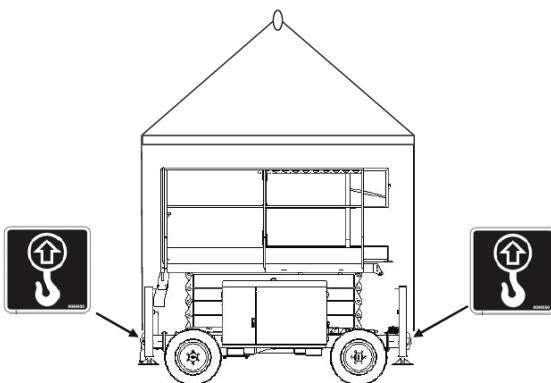

Figure 10.10 - Lifting

Pushing

The machine can be safely pushed on level, firm surfaces. The procedure for pushing is located in the emergency operation chapter.

Winching Procedure

1. Locate transport vehicle so that the S3970RT / S3370RT / S2770RT will not roll forward after being loaded.
2. Fully lower platform and retract extension deck.
3. Be sure the machine is centered with the loading ramps and carrier vehicle bed, and that the steering wheels are straight.
4. Attach the winch at the tie down lugs on the front (steer) end of the chassis.
5. Disengage parking brakes and open free-wheeling valve to prevent damage to the hydraulic motors. Refer to procedures outlined for pushing in the emergency operation chapter 9.
6. Winch machine onto transport vehicle.
7. Close free-wheeling valve and reset parking brakes.
8. Reset the hydraulic system by reversing these procedures.

Long Term Storage

When intending to store the S3970RT / S3370RT / S2770RT for more than 90 days without use, place the machine in covered storage, ensure the machine is isolated i.e. key removed, battery disconnect off and padlocked.

When returning a machine to service from a sustained period of disuse (over 90 days) perform the 90 day inspection. Also replace the engine oil and hydraulic oil and all filters.

10. Stowing and Transporting

This chapter lists and explains the options available for the machine.

■ Bi-Energy Option

This consists of a combination of both a diesel engine and a 24V DC motor to give a Bi-Energy option.

Specifically, a 24V DC motor is mounted in the control cabinet. This provides an alternative power source to the diesel engine.

The DC motor is powered by four (4) “Deep Cycle Traction Batteries” and has an automatic battery charger that is mounted in the control cabinet.

□ DC motor

The DC motor located in the control cabinet (see figure 11.1).

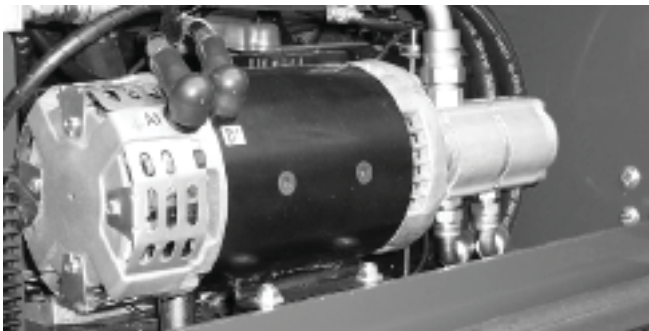

Figure 11.1 - DC Motor

□ DC Motor Operation

A diesel / electric switch, on the lower control box (see figure 11.2) is used to select either the diesel engine or the DC motor.

If the diesel engine (switch up) is selected the DC motor will not function and if the DC motor (switch down) is selected the diesel motor will not run.



Figure 11.2 - Diesel / Electric Selection Switch

After selecting the DC mode turn the selector switch to the platform position (see figure 11.3).



Figure 11.3 - Selector Switch

When entering the platform turn the fuel switch to the electric position (down) at the platform control box (see figure 11.4).

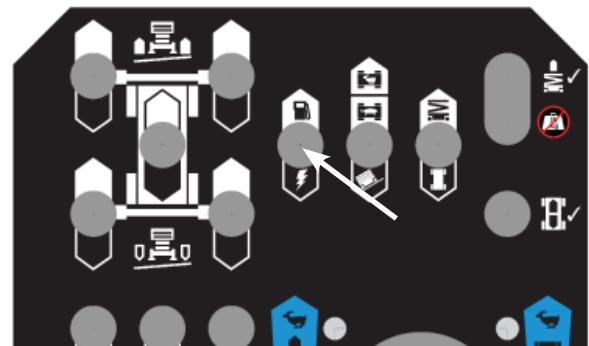

Figure 11.4 - Fuel Switch, Platform

Once the DC mode is selected the motor will then power all of the functions including the stabilisers in the normal manner. The only difference is that the DC motor will only run when a function is selected e.g. raising the stack.

□ Master battery isolater switches

There are two (2) master battery isolater switches mounted at the end of the control cabinet (see figure 11.5).

When the machine is not being used and is stowed both of these battery isolater switches should be turned to the “off” position.

When operating with the diesel motor the 24V DC battery isolater switch should be switched to the “off” position.

When operating the 24V DC motor the diesel battery isolater switch should be turned to the “off” position.

11. Options

□ Batteries

Since the Bi-Energy S3970RT / S3370RT / S2770RT is powered by “Deep Cycle Traction Batteries” particular attention should be paid to the batteries on board charger to ensure proper operation.

The batteries are enclosed in a cabinet mounted at the front of the machine.

Unscrew the knurled knobs at each end of the cabinet to remove the lid to gain access to the batteries (see figure 11.5).

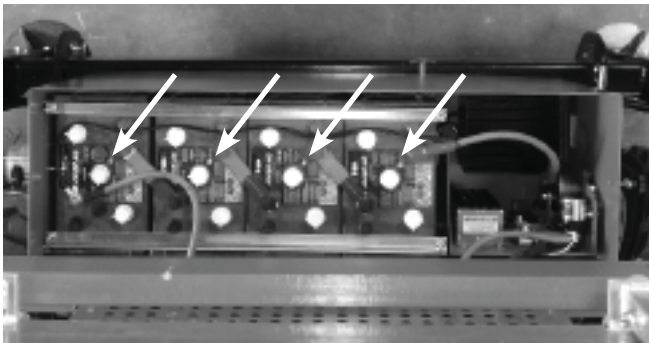

Figure 11.5 - DC Motor Batteries

▲ IMPORTANT

The cabinet lid must be open whilst charging to allow gasses to escape.

▲ DANGER

Lead-acid batteries contain sulphuric acid which will damage eyes or skin on contact. When working around batteries ALWAYS wear a face shield to avoid acid in the eyes. If acid contacts eyes, flush immediately with clear water and get medical attention.

Wear rubber gloves and protective clothing to keep acid off the skin, if acid contacts the skin, wash it off immediately with clear water.

Lead-acid batteries produce flammable and explosive gasses. NEVER allow smoking, flames or sparks around batteries.

□ Battery Charger

The Bi-Energy S3970RT / S3370RT / S2770RT is fitted with an onboard automatic battery charger (see figure 11.6). The charger will completely recharge the batteries and automatically turn off after the cycle is completed.

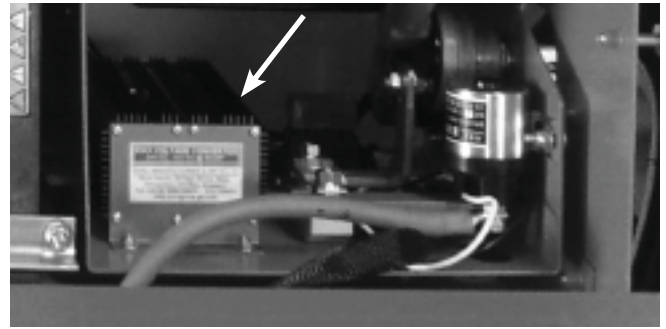

Figure 11.6 - On-Board Battery Charger

The battery charger is fitted with an ‘interlock’. This means that during the charging cycle all functions on the machine are inoperative and will remain so until the charger unit is switched off.

The charging cycle may last from 1 to 12 hours depending on that state of the batteries.

If the charging cycle should exceed 16 hours (indicating a fault) the charger will automatically shut down and the batteries should be checked.

The inlet for connections of mains power to the charger is mounted on the external walls of the control cabinet above the battery isolator switches (see figure 11.7).



Figure 11.7 - Mains Power Connection For Charger

▲ IMPORTANT

DO NOT recharge the batteries unless the electrolyte level has been checked.

DO ENSURE the cabinet lid is open during charging to allow gasses to escape.

▲ DANGER

DO NOT allow smoking, flames or sparks around batteries.

□ Batteries - General Maintenance

Always keep the batteries clean, free of dirt and corrosion. A film on top of the battery can accelerate discharge.

Cold reduces battery capacity and retards charging. Heat increases water usage and can (in extreme circumstances) result in overheating.

Use distilled water to refill the batteries. Avoid water containing metallic solids such as iron.

□ Batteries - Charging

Fully recharge the batteries, immediately after use. One (1) charging cycle per day is preferred. Fully charged batteries perform best. The deeper the discharge, the fewer number of cycles a battery will deliver. Deep discharges deteriorate the battery quicker than shallow cycles.

An overly discharged battery may need to be cycled a few times before it can fully recover. If a battery begins to heat before becoming fully charged, it may be necessary to recharge and discharge the battery a few times.

The S3970RT / S3370RT / S2770RT is equipped with an automatic battery charger that will completely recharge the batteries and turn off after the cycle is completed.

■ Gasoline / LPG Fuel Option

This section explains how to start and run the machine that has a gasoline engine. Starting a gasoline engine that is set up to burn LP-only or dual-fuel is also discussed in this section. Read and understand all the previous chapters before you begin to operate the machine.

The S3970RT / S3370RT / S2770RT has the option of being powered by a gasoline engine. If it has a gasoline engine you need to know whether it is set up to burn LP-only, or dual-fuel (LP or gasoline). If it is set up to burn dual-fuel you have to decide whether to burn gasoline or LP. The simplest way to tell what kind of engine set up you have is to look in the fuel compartment on the left side of the S3970RT / S3370RT / S2770RT open both fuel compartment doors.

- If the only fuel source you see there is a tank labeled GASOLINE FUEL, the machine has a gasoline engine set up to burn gasoline.

- If the only fuel source you see is one (1) or more LP tanks, the machine has a special gasoline engine set up to burn LP only.

- If you see a gasoline fuel tank and one (1) or more LP tanks, the machine has a special gasoline engine set up to burn either gasoline or LP.

Once you have determined the type of engine installed and the type of fuel you will burn you should go to the corresponding subsection below that explains how to start that type of engine.

□ Fuel Level

Check the level of gasoline in the fuel tank and / or the amount of LP gas in the cylinder(s). To check the amount of LP gas read the fuel meter (3) (see figure 11.10).

□ LPG Tank Gauges & Fuel Level

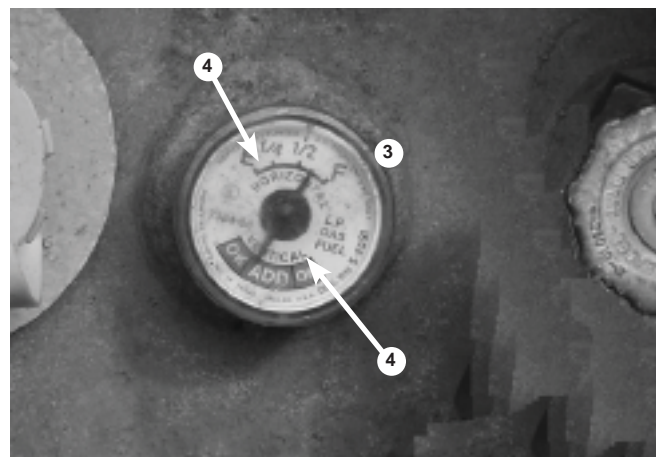

Figure 11.10 - Fuel Level Gauge

LPG tanks have two (2) fuel gauges on top. One measures correctly when the tank is standing on end (vertical) (2), the other measures correctly when the tank is laying down (horizontal) (1). Both read in fractions-of-a-full-tank (see figure 11.10).

11. Options

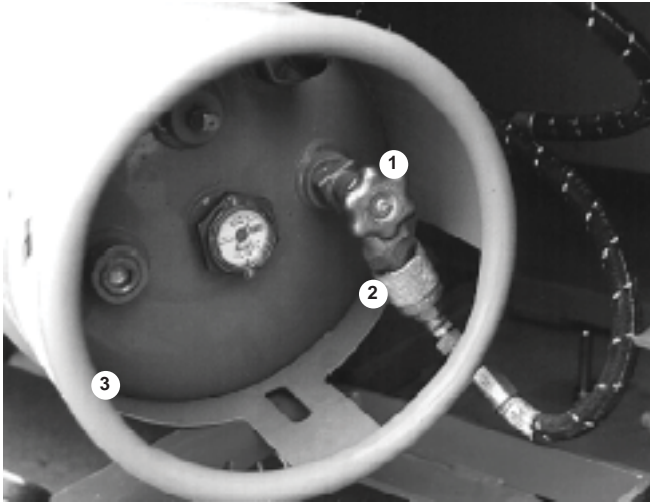

Figure 11.11 - LPG Fuel Tank Replacement

To replace an LPG tank: Close the valve (1) (see figure 11.11) Manually disconnect the fuel hose at the knurled ring (2) and lift the tank (3) out.

Note

LPG fuel installations are usually fitted post production and may vary from machine to machine. It is the operators responsibility therefore, to be aware of how the system is installed on their individual machine and know which gauge (horizontal or vertical) to read.

■ **Operating From The Ground Control Box**

Before you begin to operate the S3970RT / S3370RT / S2770RT from the ground control box, a qualified operator must perform the daily inspection and maintenance as described in chapter 7 of this manual.

To start a gasoline, LP-only or dual-fuel (LP & gasoline) engine from the ground control box do the following:

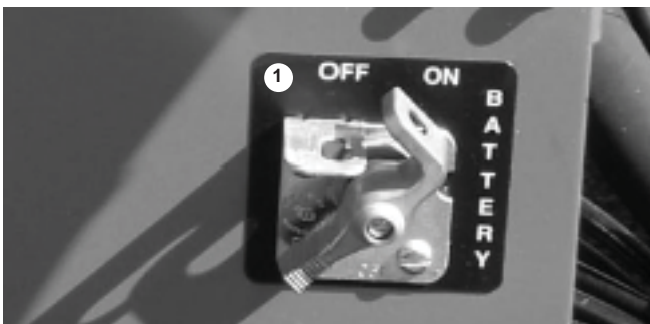

Figure 11.12

1. Set the battery switch (1) (see figure 11.12) to on.



Figure 11.13

2. Set the emergency stop switch (2) to on (out).
3. Set the ground / platform selector switch (3) to ground (down) (see figure 11.13).

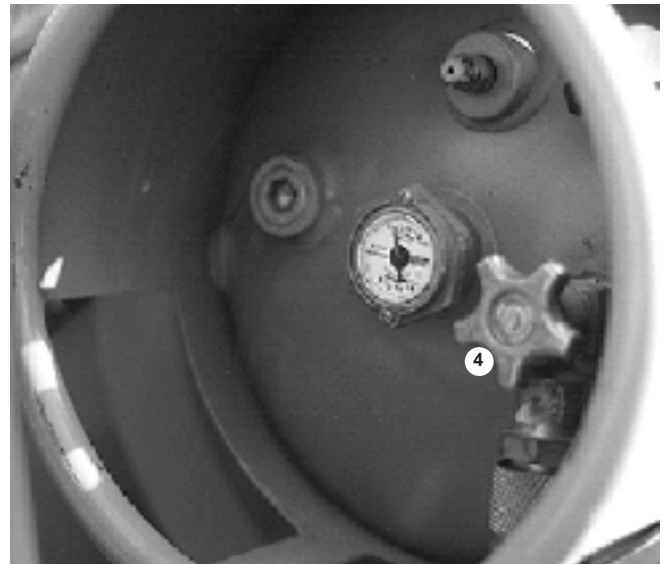

Figure 11.14

4. For LP operation: Completely open the valve (1) (see figure 11.14) on top of the LP tank (unscrew counterclockwise until it stops).

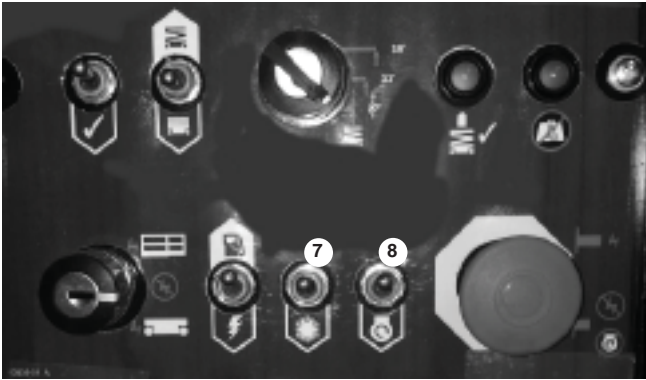

Figure 11.15

5. For a dual-fuel engine: Set the fuel switch (not shown here) to LP fuel or gasoline fuel depending on which you want to use.
6. If the engine is cold, press and hold the choke switch (7) during the next step.
7. Press the start switch (8) down and hold it there until the engine starts or for 20 seconds, whichever comes first. When the engine starts, release both the start switch (8) and the choke switch (7).

⚠ CAUTION

If the engine does not start in 20 seconds, release the start switch (8) and the choke switch (7) then wait 60 seconds before trying to start the engine again.

■ Operating From The Platform Control Box

Before you begin to operate the S3970RT / S3370RT / S2770RT from the platform control box, a qualified operator must perform the daily inspection and maintenance as described in chapter 7 of this manual.

To start a gasoline, LP-only or dual-fuel (LP & gasoline) engine from the platform control box do the following:

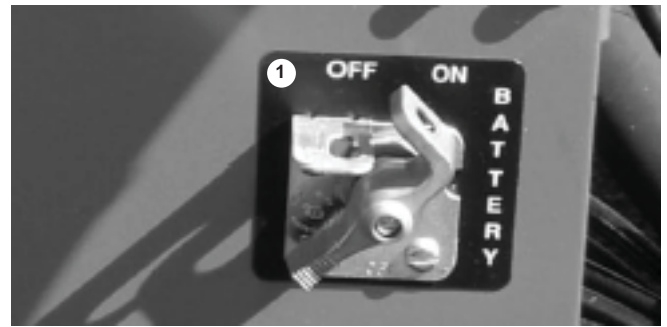

Figure 11.16

1. Set the battery switch (1) to on (see figure 11.16).



Figure 11.17

2. Set the emergency stop switch (2) to on (out) (see figure 11.17).
3. Set the ground / platform selector switch (3) to platform (up) (see figure 11.17).

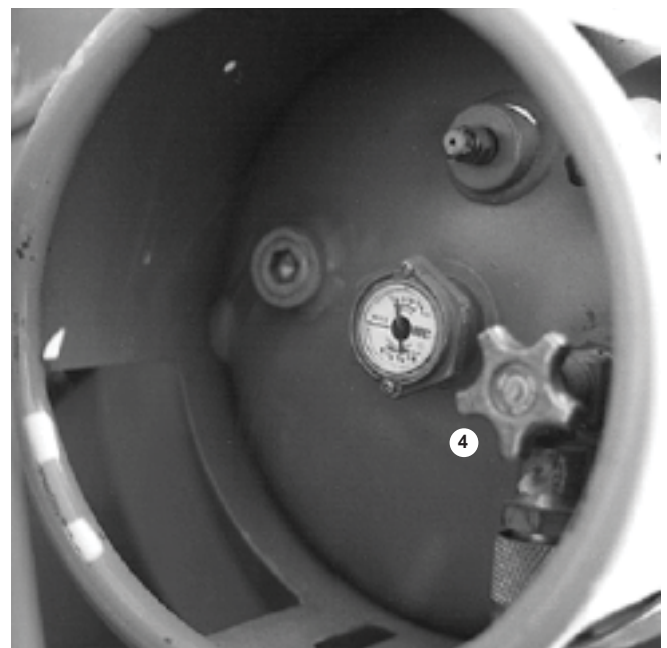

Figure 11.18

11. Options

- For LP operation: completely open the valve (4) (see figure 11.18) on top of the LP tank (unscrew counterclockwise until it stops).
- For a dual-fuel engine: On the lower control box, set the fuel switch (not shown here) to gasoline or LP gas depending on which you want to use.
- Enter the platform and close the gate.

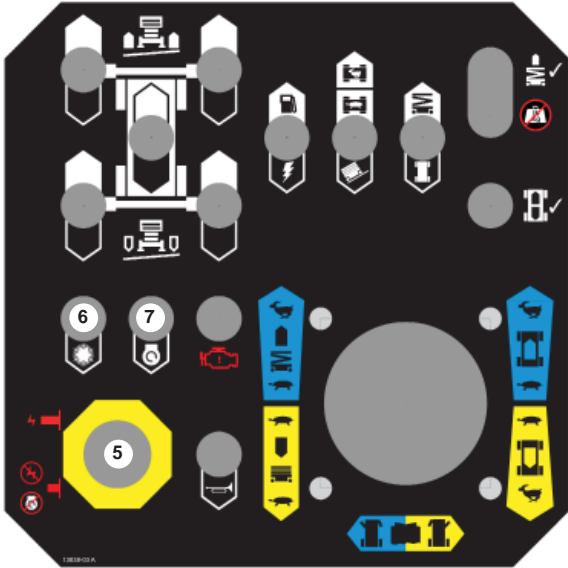

Figure 11.20

- Pull the emergency stop switch (5) outward (on) (see figure 11.20).
- If the engine is cold, press and hold the choke switch (6) during the next step.
- Press and hold the start switch (7) down until the engine starts or for 20 seconds, whichever comes first. When the engine starts, release both the start switch (7) and the choke switch (6).

⚠ CAUTION

If the engine does not start in 20 seconds, release the start switch (7) and release the choke switch (6) then wait 60 seconds before trying to start the engine again.

■ RCD / ELCB Outlet



Figure 11.21 - RCD / ELCB Outlet

The RCD (Residual Current Device) is located at the ground and will protect against short circuits to earth. When there is a short circuit the RCD will shut down the 230V AC power to the platform outlet.

To reset the outlet disconnect the power tool lead from the platform box and reset the RCD at the ground.

If the problem persists call a trained service technician.

■ Fall Restraint Lanyard Anchor Points (Option)

There are three (3) Fall Restraint anchor points on the floor of the platform for the S3970RT / S3370RT / S2770RT, two (2) behind the roll-out deck when retracted and one (1) behind the roll-out deck when extended.

⚠ DANGER

The Fall Restraint Anchor points are rated for Fall Restraint only. A Fall Arrest System must not be attached. Death or serious injury could result from use of a Fall Arrest System.

The anchor points are positioned such that a Fall Restraint Lanyard can be set short enough to prevent the operator reaching the fall hazard (when not all guard rails are in place) while still allowing some freedom of movement.

Note

These anchors are not for lifting or tying down the machine.

You should attach your fall protection to the anchors if work rules require it.

■ Electrical Outlet

Figure 11.22 - Electrical Outlet

The electrical outlet on the platform, and its power cable are designed to supply 2 kW of continuous duty power to run power tools of various sorts. The power can come from either the optional AC generator, discussed elsewhere in this chapter, or from an electrical source outside the machine. If you use an electrical source outside the machine be sure you disconnect it before you drive away.

■ Non-Marking Tyres

These are tyres suited for using the S3970RT / S3370RT / S2770RT in indoor situations.

■ Alternative Power Options

These are a number of alternative power options to the standard diesel engine:

- Gasoline powered engine
- LPG powered engine
- Combination LPG / Gasoline powered engine

■ Stabilisers

Stabilisers / No Stabilisers.

11. Options

12. Fire Fighting and Chemical Containment

■ Hazardous Components

The S3970RT / S3370RT / S2770RT may contain some or all of the following materials and objects that potentially could become significant fire or environmental hazards during the lifetime of a S3970RT / S3370RT / S2770RT:

1. Antifreeze (ethylene glycol)
2. Battery, lead / acid
3. Diesel fuel
4. Foam in tyres
5. Gasoline
6. Hydraulic oil
7. Liquefied petroleum gas
8. Motor oil

The rest of the chapter lists manufacturers information you will need if you ever have to control any of the above items during an upset or emergency.

□ Antifreeze (UN 1993)

Fire extinguishing media:

Dry Chemical, foam, or CO₂.

Special fire fighting procedures:

Water spray may be ineffective on fire but can protect fire fighters and cool closed containers. Use fog nozzles if water is used.

DANGER

DO NOT enter confined fire space without full bunker gear. (Helmet with face shield, bunker coats, gloves and rubber boots). Use a NIOSH approved positive pressure self contained breathing apparatus. Keep container tightly closed. Isolate from oxidizers, heat and open flame.

Spill or leak:

Small - mop up with absorbent material and transfer to hood.

Waste disposal method:

Small - evaporate until all vapors are gone. Dispose of remainder by legally applicable methods.

□ Battery, lead/acid (UN 2794)

Extinguishing media:

Dry chemical, foam or CO₂.

Special fire fighting procedures:

Use positive pressure, self contained breathing apparatus.

Unusual fire and explosion hazards:

Hydrogen and oxygen gases are produced in the cells during normal battery operation.

DANGER

Hydrogen gas is flammable and oxygen supports combustion. These gases enter the air through the vent caps. To avoid the chance of a fire or explosion, keep sparks and other sources of ignition away from the battery.

Spill or leak:

Remove combustible materials and all sources of ignition. Contain spill by diking with soda ash (sodium carbonate) or quicklime (calcium oxide). Cover spill with either chemical. Mix well. Make certain mixture is neutral then collect residue and place in a drum or other suitable container. Dispose of as a hazardous waste.

DANGER

ALWAYS wear acid resistant boots, face shield, chemical splash goggles and acid resistant gloves when handling acid spills or leaks.

Note

Do not release UN-neutralized acid!

Waste disposal method:

Sulphuric acid: Neutralize as above for a spill, collect residue and place in a drum or suitable container. Dispose of as a hazardous waste.

Note

Do not flush lead contaminated acid to sewer.

Waste disposal method:

Batteries: Send to lead smelter for reclamation following applicable federal, state and local regulations.

□ Diesel fuel (NA 1993)

Extinguishing media:

Use water spray, dry chemical, foam or CO₂.

12. Fire Fighting and Chemical Containment

Special fire fighting procedures:

Use water to keep fire exposed containers cool. If leak or spill has not ignited, use water spray to disperse the vapors and to provide protection for personnel attempting to stop a leak. Water spray may be used to flush spills away from exposures.

Unusual fire and explosion hazards:

Products of combustion may contain carbon monoxide, carbon dioxide and other toxic materials.

DANGER

DO NOT enter enclosed or confined space without proper protective equipment including respiratory protection.

Spill or leak:

Contain spill immediately in smallest area possible. Recover as much of the product itself as possible by such methods as vacuuming, followed by soaking up of residual fluids by use of absorbent materials.

Remove contaminated items including contaminated soil and place in proper containers for disposal. Avoid washing, draining or directing material to storm or sanitary sewers.

Waste disposal method:

Recycle as much of the recoverable product as possible.

Dispose of non-recyclable material as a RCRA hazardous waste by such methods as incineration, complying with federal, state and local regulations.

Foam in tyres

Extinguishing media:

Water, dry chemical, foam or CO₂.

Special fire fighting procedures:

Evacuate non emergency personnel to a safe area.

Unusual fire and explosion hazards:

Fire fighters should use self contained breathing apparatus. Avoid breathing smoke, fumes and decomposition products. Use water spray to drench smoldering elastomer. Product may melt after ignition to form flammable liquid.

DANGER

Burning procedures intense heat, dense smoke and toxic gases such as carbon monoxide, oxides of nitrogen and traces of hydrogen cyanide.

Spill or leak:

Pick up and handle as any other inert solid material.

Waste disposal method:

Not considered a hazardous material. Dispose of material according to any local, state and federal regulations.

Gasoline (UN 1203)

Extinguishing media:

Dry chemical, foam or CO₂.

Special fire fighting procedures:

Water may be ineffective to extinguish, but water should be used to keep fire exposed containers cool. If a leak or spill has not ignited, use water spray to disperse the vapors and to protect personnel attempting to stop a leak. Water spray may be used to flush spills away from areas of potential ignition.

Unusual fire and explosion hazards:

Highly flammable. Products of combustion may contain carbon monoxide, carbon dioxide and other toxic materials.

DANGER

DO NOT enter enclosed or confined space without proper protective equipment including respiratory protection.

Spill or leak:

Review fire and explosion hazards before proceeding with clean up. Use appropriate personal protective equipment during clean up. Dike spill. Prevent liquid from entering sewers, water ways, or low areas. Soak up with sawdust, sand, oil dry or other absorbent material. Shovel or sweep up.

Remove source of heat, sparks, flame, impact, friction or electricity including internal combustion engines and power tools. If equipment is used for spill cleanup, it must be explosion proof and suitable for flammable liquid and vapor.

12. Fire Fighting and Chemical Containment

Note

Vapors released from the spill may create an explosive atmosphere.

Waste disposal method:

Treatment, storage, transportation and disposal must be in accordance with applicable federal, state, provincial and local regulations.

CAUTION

Do not flush to surface water or sanitary sewer system. By itself, the liquid is expected to be a RCRA ignitable hazardous waste.

Hydraulic oil (UN 1270)

Extinguishing media:

Use water spray, dry chemical, foam or CO₂.

Special fire fighting procedures:

Water or foam may cause frothing. Use water to keep fire exposed containers cool. Water spray may be used to flush spills away from exposures.

Unusual fire and explosion hazards:

Products of combustion may contain carbon monoxide, carbon dioxide and other toxic materials.

DANGER

Do not enter enclosed or confined space without proper protective equipment including respiratory protection.

Spill or leak:

Contain spill immediately in smallest area possible. Recover as much of the product itself as possible by such methods as vacuuming, followed by soaking up of residual fluids by use of absorbent materials.

Remove contaminated items including contaminated soil and place in proper containers for disposal. Avoid washing, draining or directing material to storm or sanitary sewers.

Waste disposal method:

Recycle as much of the recoverable product as possible. Dispose of non recyclable material as a RCRA hazardous waste by such methods as incineration,

complying with federal, state and local regulations.

Liquefied petroleum gas (UN 1075)

Extinguishing media:

Water spray. Class A-B-C or BC fire extinguishers.

Special fire fighting procedures:

Stop flow of gas. Use water to keep fire exposed containers cool. Use water spray to disperse unignited gas or vapor.

If ignition has occurred and no water available, tank metal may weaken from over heating. Evacuate area. If gas is not ignited, LP gas liquid or vapor may be dispersed by water spray or flooding.

Unusual fire and explosion hazards:

Highly flammable. Products of combustion may contain carbon monoxide, carbon dioxide and other toxic materials.

DANGER

DO NOT enter enclosed or confined space without proper protective equipment including respiratory protection.

Spill or leak:

Keep public away. Shut off supply of gas. Eliminate sources of ignition. Ventilate the area. Disperse with water spray.

Contact between skin and these gases in liquid form can cause freezing of tissue causing injury similar to thermal burn.

Note

Vapors released from the spill may create an explosive atmosphere.

Waste disposal method:

Treatment, storage, transportation and disposal must be in accordance with applicable federal, state, provincial and local regulations.

Motor oil (UN 1270)

Extinguishing media:

Use water spray, dry chemical, foam or CO₂.

12. Fire Fighting and Chemical Containment

Special fire fighting procedures:

Water or foam may cause frothing. Use water to keep fire exposed containers cool. Water spray may be used to flush spills away from exposures.

Unusual fire and explosion hazards:

Products of combustion may contain carbon monoxide, carbon dioxide and other toxic materials.

DANGER

DO NOT enter enclosed or confined space without proper protective equipment including respiratory protection.

Spill or leak:

Contain spill immediately in smallest area possible. Recover as much of the product itself as possible by such methods as vacuuming, followed by soaking up of residual fluids by use of absorbent materials.

Remove contaminated items including contaminated soil and place in proper containers for disposal. Avoid washing, draining or directing material to storm or sanitary sewers.

Waste disposal method:

Recycle as much of the recoverable product as possible.

Dispose of non-recyclable material as a RCRA hazardous waste by such methods as incineration, complying with federal, state and local regulations.

13. Operators Troubleshooting

■ Troubleshooting

All of the actions described in this chapter may be performed by the machine operator, a trained and qualified service technician is not required.

The first column of the following charts lists some common problems encountered by the S3970RT / S3370RT / S2770RT operators.

□ Operator troubleshooting chart

The second column lists some of the causes for each problem. The third column lists remedies.

CAUTION

Any problem that cannot be fixed by actions listed below should be referred to a trained and qualified S3970RT / S3370RT / S3370RT service technician.

Problem	Cause	Remedy
Engine will not start.	Battery switch set to off.	Turn battery switch to on.
	Emergency Stop switch(es) not on.	Set the ground control Emergency Stop switch to on (up). Also, if you are trying to start at the platform control box you should pull the Emergency Stop switch, at the platform control box, until it pops out (on).
	Key switch set to off.	Set the Key switch to on (the bar symbol).
	Ground/Platform Selector switch set to wrong location.	If you are trying to start from the ground control box, set the Ground/Platform selector to ground (down). If you are trying to start from the platform, set the selector to platform (up).
	Fuse blown.	Replace fuse.
	Fuel switch not set correctly.	If you are trying to start a dual-fuel engine be sure the fuel switch is set to the correct fuel.
	Out of fuel.	DANGER: Keep flames and lit tobacco away from open fuel tanks. Remove the cap from the gasoline or diesel tank to see if there is fuel. Check the gauge(s) on top of the LP tank(s). If you are using LP gas, be sure the valve on top of the tank is open.
	Clogged air filter.	Visually check the air filter gauge.
Engine oil too thick for ambient temperature.	Check engine oil chart in "Specifications" chapter 3 for correct oil weight.	
Stabilisers inoperative	Platform not completely down.	Completely lower the platform.
All systems sluggish.	Hydraulic oil is too thick.	Check for correct grade of Hydraulic Oil. Allow time for machine to warm up.
S3970RT / S3370RT / S2770RT will not drive forward or reverse.	Free-wheeling valve is open.	Close the free-wheeling valve.

13. Operators Troubleshooting

Problem	Cause	Remedy
Platform will not go up or down.	Engine is not running.	Start the engine from the control station where you will operate the S3970RT / S3370RT / S2770RT.
	Switches set wrong (Lift Indicator light is lit).	<p><u>For ground control operation:</u></p> <p>Ground/Platform Selector = Ground</p> <p><u>For platform control box operation:</u></p> <p>Ground/Platform Selector = Platform Lift/Drive Selector = Lift</p> <p>Squeeze and hold the Safety Control then push Joystick Controller forward to go up or pull it backward to go down.</p>
	S3970RT / S3370RT / S2770RT is not level. (Lift Indicator light is not lit and the Level Sensor Alarm is sounding).	Use the stabilisers to level the S3970RT / S3370RT / S2770RT.
	The Stabilisers are not properly set. (Lift Indicator light is not lit).	<p>If you are using the stabilisers, one (1) or more of them is not down quite far enough. Lower each stabiliser a few inches more to be sure each is firmly in contact with the ground.</p> <p>If you are not using the stabilisers, one (1) or more of them is not fully up. Raise each stabiliser completely up.</p>
Platform will not drive forward or reverse when raised.	Unit not level. Articulating axle operated.	Situation normal, lower platform to drive.

- **Aerial platform**

A mobile device that has an adjustable position platform, supported from ground level by a structure.

- **Ambient temperature**

The air temperature of the immediate environment.

- **Ammeter**

An instrument for measuring the strength of an electric current in amperes.

- **Authorised personnel**

Personnel approved as assigned to perform specific duties at a specific location.

- **Base**

The relevant contact points of the aerial platform that form the stability support (e.g. wheels, casters, outriggers, stabilisers).

- **Boom**

A movable cantilever beam which supports the platform.

- **Center of gravity**

The point in the aerial platform around which its weight is evenly balanced.

- **Chassis**

The integral part of the aerial platform that provides mobility and support for the booms.

- **Fall arrest system**

Is the form of fall protection which involves the safe stopping of a person already falling. The system includes:

A: Anchorage - a fixed structure to which the components of the system are rigged.

B: Body Wear - a full body harness worn by the person (referred to as a “safety harness” in this manual).

C: Connector - a subsystem component connecting the harness to the anchorage, such as a lanyard.

D: Deceleration Device - a subsystem component designed to dissipate the forces associated with a fall arrest event.

- **Fall arrest**

Is the form of personal fall protection which prevents persons who are in a fall hazard area from falling. The system includes:

A: Anchorage - a fixed structure to which the components of the system are rigged.

B: Body Wear - a full body harness worn by the person (referred to as a “safety harness” in this manual).

C: Connector - a subsystem component connecting the harness to the anchorage, such as a lanyard. The lanyard is short enough that the person can not reach the fall hazard.

- **Ground pressure**

The maximum pressure, expressed in pounds per square inch, a single wheel concentrates on the floor or ground.

- **Gradeability**

The maximum slope that the aerial platform is capable of travel.

- **Ground fault circuit interrupter or residual current detector**

A fast acting circuit breaker that opens to stop electrical circuit flow if it senses a very small current leakage to ground. The GFCI/RCD is used to protect personnel against a potential shock hazard from defective electrical tools or wiring.

- **Guardrail system**

The primary fall protection system to eliminate the fall hazard. The system includes toe boards, midrail, toprail and uprights.

- **Hazardous location**

Any location that contains, or has the potential to contain, an explosive or flammable atmosphere as defined by ANSI/NFPA 505.

- **Jib boom**

A boom assembly located between the main boom and the platform.

- **Level Sensor**

A device that detects a present degree of variation from perfect level. The level sensor is used to sound an alarm if operating on a slope greater than the present value. It may also (depending on the machine) prevent it from operating further until it is brought back within the present parameters.

- **Lower controls**

The controls located at ground level for operating some or all of the functions of the aerial platform.

Appendix A. Glossary

- **Main boom**

A boom assembly located between the turntable and the platform or jib boom. The main boom includes the base, intermediate and tip boom.

- **Maximum travel height**

The maximum platform height or the most adverse configuration(s) with respect to stability in which travel is permitted by the manufacturer.

- **Minimum safe approach distance**

The minimum safe distance that electrical conductors may be approached when using the aerial platform. Also called MST.

- **Operation**

The performance of an aerial platform functions within the scope of its specifications and in accordance with the manufacturers instructions, the users work rules and all applicable governmental regulations.

- **Operator**

A qualified person who controls the movement of an aerial platform.

- **Platform**

The portion of an aerial platform intended to be occupied by personnel with their tools and materials.

- **Platform height**

The vertical distance measured from the floor of the platform to the surface upon which the chassis is being supported.

- **Prestart inspection**

A required safety inspection routine that is performed daily before operating the aerial platform.

- **Qualified person**

A person, who by reason of knowledge, experience or training is familiar with the operation to be performed and the hazards involved.

- **Rated work load**

The designed carrying capacity of the aerial platform in its rest position.

- **Stow**

To place a component, such as the platform, in its rest position.

- **Turning radius**

The radius of the circle created by the wheel during a 360 degree turn with the steering wheels turned to maximum. Inside turning radius is the wheel closest

to the center and outside turning radius is the wheel farthest from the center.

- **Turntable**

The structure above the rotation bearing which supports the main boom. The turntable rotates about the centerline of the rotation.

- **Unrestricted rated work load**

The maximum designed carrying capacity of the aerial platform allowed by the manufacturer in all operating configurations.

- **Upper controls**

The controls located on or beside the platform used for operating some or all of the functions of the aerial platform.

- **Wheelbase**

The distance from the center of the rear wheel to the center of the front wheel.

- **Working envelope**

The area defined by the horizontal and vertical limits of boom travel that the platform may be positioned in.

**Local Distributor / Lokaler Vertiebs Händler / Distributeur local
El Distribuidor local / Il Distributore locale**

**EUROPE, MIDDLE EAST
AFRICA & ASIA**

PHONE: +44 (0) 845 1550 057

FAX: +44 (0) 845 1557 756

NORTH & SOUTH AMERICA

PHONE: +1 785 989 3000

TOLL FREE: +1 800 255 0317

FAX: +1 785 989 3070

AUSTRALIA

PHONE: +64 2 9725 4000

FAX: +64 2 9609 3057

NEW ZEALAND

PHONE: +64 6 3689 168

FAX: +64 6 3689 164

